

 *Tapizados*  
Juan Díaz, S.L.



# “MATRIX”

CHAISELONGUE RELAX MOTORIZADO



*Juan Díaz*

# “MATRIX”

CHAISELONGUE RELAX MOTORIZADO



OPCIÓN SOFÁ 2 PLAZAS



OPCIÓN SOFÁ 3 PLAZAS ABIERTO



DETALLE RELAX ABIERTO

Juan Díaz



MECANISMOS ASIENTOS RELAX MOTORIZADOS



ARCÓN ABATIBLE EN LA CHAISELONGUE. ARCÓN **OPCIONAL** EN BRAZO DE LA CHAISELONGUE INCREMENTA **80 PUNTOS**.



2 PUFFS LATERALES **OPCIONALES** EN BRAZO.

### OBSERVACIONES

**IMPORTANTE! SE DEBE INDICAR LA MANO DE LOS CHAISELONGUE VISTOS DE FRENTE.**

#### ESTRUCTURA

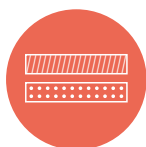

MADERA DE PINO MACIZO REFORZADA CON ESCUADRAS Y LATERALES CON AGLOMERADO DE ALTA RESISTENCIA.

#### ASIENTOS



MOTORIZADOS ELÉCTRICOS/ESPUMAS DE 30 KG

#### RESPALDOS



RECLINABLES Y BRAZOS SIESTA: CON FIBRA HUECA SILICONADA 100%

#### DE SERIE



PIES METÁLICOS DELANTEROS Y BRAZO DE SIESTA CON FIBRA HUECA SILICONADA. ARCÓN EN LA CHAISELONGUE Y PUFF LATERALES, CUANDO ES CHAISELONGUE COMPLETA.

# MATRIX

		ALTO	FONDO	ANCHO	BULTOS	PLAZAS
	MODELO 2 PLAZAS (2 ASIENTOS ELEC. + CHAISELONGUE) 275	1,05	1,75	2,75	3	4
	MODELO 3 PLAZAS (2 ASIENTOS + CHAISELONGUE) EXT. 300	1,05	1,75	3,00	3	4
	MÓDULO 1 PLAZA CON BRAZO 100/110	1,05	0,95	1,00/1,10	1	1
	MÓDULO 1 PLAZA SIN BRAZO 70/80	1,05	0,95	0,70/0,80	1	1
	INCREMENTO BRAZO CON PUFF					
	INCREMENTO ARCÓN EN EL BRAZO DE LA CHAISELONGUE					

**Juan Díaz, S.L.**

CHAISELONGUE RELAX MOTORIZADO

# “SIBERIA”

SOFÁ 2/3 PLAZAS

CHAISELONGUE

RINCONERA



*Juan Díaz*

# "SIBERIA"

CHAISELONGUE



OPCIÓN RINCONERA



OPCIÓN CHAISELONGUE RINCÓN



OPCIÓN SOFÁ 2 PLAZAS

Juan Díaz

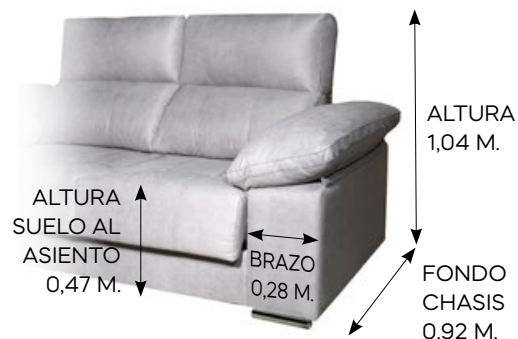

ASIENTOS DESLIZANTES  
CABEZALES RECLINABLES



ARCÓN ABATIBLE



OPCIÓN PATA ALTA (CUANDO NO LLEVE PUFFS LATERALES):  
COMPUERTO POR 4 PATAS ALTAS METÁLICAS SEGÚN FOTO  
CATÁLOGO + 1 PATA REDONDA + TORNILLERÍA

## OBSERVACIONES

**IMPORTANTE! SE DEBE INDICAR LA MANO DE LOS CHAISLONGUE VISTOS DE FRENTE.**

## EL CHAISLONGUE RINCÓN NO LLEVA ARCÓN

### ESTRUCTURA

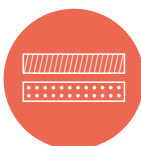

MADERA DE PINO MACIZO REFORZADA CON ESCUADRAS Y  
LATERALES CON AGLOMERADO DE ALTA RESISTENCIA

### ASIENTOS

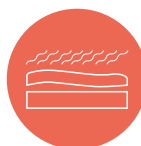

DESLIZANTES METÁLICOS DE RUEDAS Y  
POSICIONES PUNTO A PUNTO /  
ESPUMAS DE 30KG HR

### RESPALDOS



RECLINABLES CON FIBRA  
HUECA SILICONADA 100%

### DE SERIE



PIES METÁLICOS DELANTEROS  
Y BRAZO DE SIESTA

# SIBERIA

		ALTO	FONDO	ANCHO	BULTOS	PLAZAS
	MOD. 2 PLAZAS (2 ASIENTOS + CHAISLONGUE) - EXT. 255	1,07	1,75	2,55	2	4
	MOD. 2 PLAZAS (2 ASIENTOS + CHAISLONGUE) EXT. 280	1,05	1,70	2,80	2	4
	MOD. 3 PLAZAS (2 ASIENTOS + CHAISLONGUE) - EXT. 300	1,05	1,70	3,00	2	4
	MOD. 3 PLAZAS (2 ASIENTOS + CHAISLONGUE RINCÓN) - EXT. 285	1,10	2,02	2,85	2	4
	SOFÁ 3 PLAZAS (2 COJINES) EXT. 200	1,07	0,95	2,00	1	3
	SOFÁ 2 PLAZAS (2 COJINES) EXT. 177	1,07	0,95	1,77	1	2
	CONJUNTO 3 + 2 EXT.					
	SOFÁ 3 PLAZAS (3 ASIENTOS) EXT. 255	1,07	0,95	2,50	2	3
	SOFÁ 3 PLAZAS (3 ASIENTOS) EXT. 280	1,05	0,95	2,80	2	3
	SOFÁ 3 PLAZAS (3 ASIENTOS) EXT. 300	1,05	0,95	3,00	2	3
	MÓDULO RINCÓN	1,07	1,10	1,10	1	1
	MÓDULO 1 PLAZA C/B	1,07	0,95	0,95/1,05	1	1
	MÓDULO 2/PLAZAS C/B (2 ASIENTOS) EXT.	1,07	0,95	1,53	1	2
	MÓDULO 3/PLAZAS C/B (2 ASIENTOS) EXT.	1,07	0,95	1,78	1	3
	MÓDULO 1 PLAZA S/B EXT. 0.63/0.73	1,07	0,95	0,63/0,73	1	1
	MÓDULO 2/PLAZAS S/B (2 ASIENTOS) EXT.	1,07	0,95	1,23	1	2
	MÓDULO 3/PLAZAS S/B (2 ASIENTOS) EXT.	1,07	0,95	1,48	1	3
	PUFF REVERSIBLE 250/280/300	0,70	0,75	0,98	1	1
	MÓDULO CHAISE LONGUE C/B Y ARCÓN	1,07	1,75	1,00	1	2
	BRAZO CON PUFFS LATERALES	0,30	0,95	0,30		

Tapizados Juan Díaz, S.L.

SOFÁ 2/3 PLAZAS  
CHAISLONGUE  
RINCONERA

# “GUADIANA”

SOFÁ 2/3 PLAZAS

CHAISELONGUE



*Juan Díaz*



# “GUADIANA”

CHAISELONGUE



OPCIÓN SOFÁ 2/3 PLAZAS



OPCIÓN SOFÁ 2/3 PLAZAS ABIERTO



OPCIÓN CHAISELONGUE

Juan Díaz



ASIENTOS DESLIZANTES  
CABEZALES RECLINABLES



ARCÓN ABATIBLE  
OPCIONAL

### OBSERVACIONES

**IMPORTANTE! SE DEBE INDICAR LA MANO DE LOS CHAISELONGUE VISTOS DE FRENTE.**

#### ESTRUCTURA

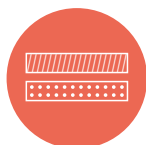

MADERA DE PINO MACIZO REFORZADA  
CON ESCUADRAS Y LATERALES CON  
AGLOMERADO DE ALTA RESISTENCIA.

#### ASIENTOS



DESILIZANTES DE RUEDAS Y  
POSICIONES PUNTO A PUNTO  
/ ESPUMAS DE 30KG HR

#### RESPALDOS



RECLINABLES  
CON FIBRA HUECA  
SILICONADA 100%.

#### DE SERIE



PATAS METÁLICAS  
Y BRAZO DE SIESTA.

# GUADIANA

		ALTO	FONDO	ANCHO	BULTOS	PLAZAS
	SOFA 3 PLAZAS (2 ASIENTOS) EXT. 200	1,05	0,95	2,00	1	3
	SOFA 2 PLAZAS (2 ASIENTOS) EXT. 177	1,05	0,95	1,77	1	2
	CONJUNTO 3 + 2 EXT.				2	5
	MOD. 2 PLAZAS 2 ASIENTOS + CHAISE LONGUE EXT. 275	1,05	1,70	2,75	2	4
	MOD. 3 PLAZAS 2 ASIENTOS + CHAISE LONGUE - EXT. 295	1,05	1,70	2,95	2	4

Tapizados Juan Díaz, S.L.

SOFÁ 2/3 PLAZAS  
CHAISELONGUE

# “LEÓN”

SOFÁ 2/3 PLAZAS

CHAISELONGUE

RINCONERA



*Juan Díaz*

# “LEÓN”

RINCONERA



OPCIÓN CHAISLONGUE RINCÓN



OPCIÓN SOFÁ 2/3 PLAZAS



OPCIÓN CHAISLONGUE

Juan Díaz

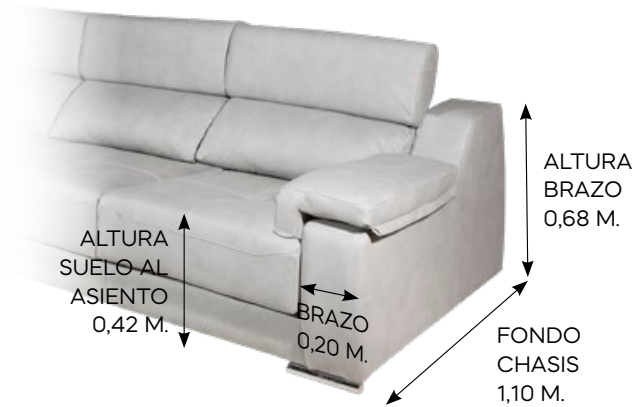

ASIENTOS DESLIZANTES  
CABEZALES RECLINABLES



OPCIÓN PATA ALTA: COMPUESTO POR 4 PATAS ALTAS METÁLICAS  
SEGÚN FOTO CATÁLOGO + 1 PATA REDONDA + TORNILLERÍA

### OBSERVACIONES

**IMPORTANTE! SE DEBE INDICAR LA MANO DE LOS CHAISERLONGUE VISTOS DE FRENTE.**

#### ESTRUCTURA

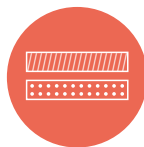

MADERA DE PINO MACIZO CON LATERALES DE CONTRACHAPADO DE 19 MM, RECUBIERTA DE ESPUMA DE POLIURETANO DE 20 KG.

#### ASIENTOS

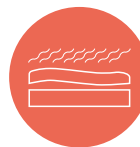

CON DESLIZANTES METÁLICOS CON COJINES DE ESPUMAS DE DENSIDAD 30 KG HR.

#### RESPALDOS Y BRAZOS



CON CABEZAL ABATIBLE Y RECLINABLE CON COJINES DE DENSIDAD 20 KG SUPER SUAVE, RECUBIERTOS CON FIBRA. BRAZO LARGO ABATIBLE.

## LEÓN

		ALTO	FONDO	ANCHO	BULTOS	PLAZAS
	SOFÁ 3 PLAZAS (2 ASIENTOS) EXT. 200	0,80/0,95	1,10	2,00	1	3
	SOFÁ 2 PLAZAS (2 ASIENTOS) EXT. 180	0,80/0,95	1,10	1,80	1	2
	MOD. 3 PLAZAS (2 ASIENTOS + CHAISE EXT. 270)	0,80/0,95	1,80	2,70	2	4
	MOD. 3 PLAZAS (2 ASIENTOS + CHAISE EXT. 300)	0,80/0,95	1,80	3,00	2	4
	MÓDULO 3/PLAZAS C/B (2 COJINES)	0,80/0,95	1,10	1,85	1	3
	MÓDULO 2/PLAZAS C/B (2 COJINES)	0,80/0,95	1,10	1,65	1	2
	MÓDULO 1 PLAZA CON BRAZO	0,80/0,95	1,10	1,02	1	1
	MÓDULO 1 PLAZA SIN BRAZO	0,80/0,95	1,10	0,85	1	1
	MÓDULO RINCÓN	0,80/0,95	1,20	1,20	1	1
	MÓDULO CHAISERLONGUE RINCÓN	0,80/0,95	2,10	1,10	1	2
	MOD. 3 PLAZAS (2 ASIENTOS + CHAISE RINCÓN EXT. 300)	0,80/0,95	2,10	2,93	2	4

Tapizados  
Juan Díaz, S.L.

SOFÁ 2/3 PLAZAS  
CHAISERLONGUE  
RINCONERA

# “GIJÓN”

SOFÁ 2/3 PLAZAS

CHAISELONGUE



*Juan Díaz*

# “GIJÓN”

CHAISELONGUE

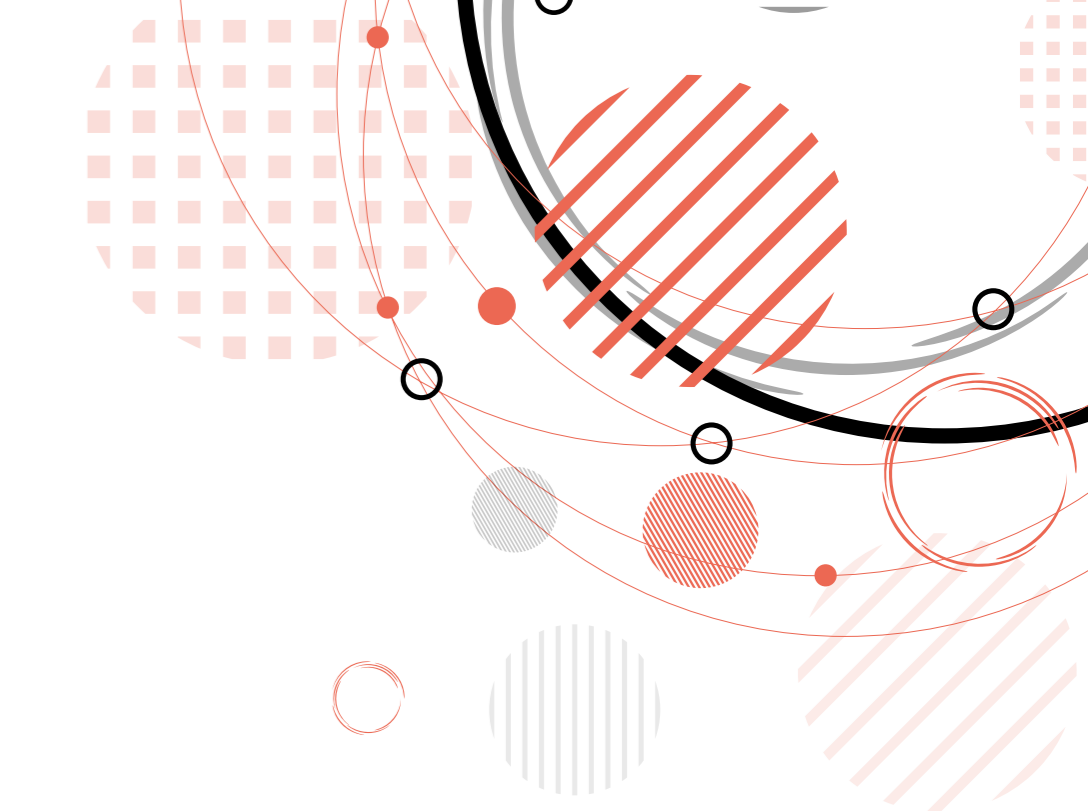

DETALLE SOFÁ 3 PLAZAS ABIERTO



DETALLE CHAISELONGUE ABIERTA

Juan Díaz

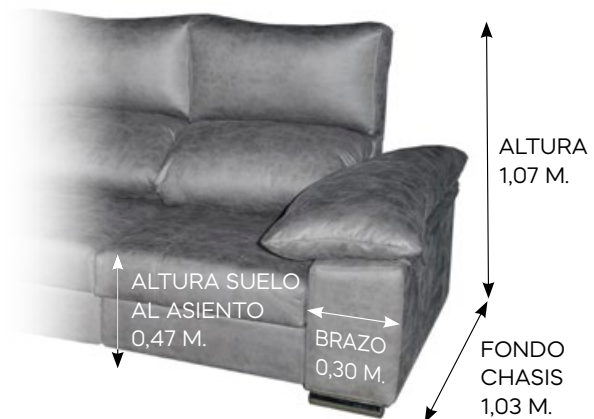

ASIENTOS DESLIZANTES  
CABEZALES RECLINABLES



ARCÓN ABATIBLE  
OPCIONAL

### OBSERVACIONES

**IMPORTANTE! SE DEBE INDICAR LA MANO DE LOS CHAISERLONGUE VISTOS DE FRENTE.**

#### ESTRUCTURA

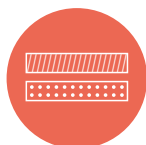

MADERA DE PINO MACIZO REFORZADA  
CON ESCUADRAS Y LATERALES CON  
AGLOMERADO DE ALTA RESISTENCIA

#### ASIENTOS



DESLIZANTES METÁLICOS  
DE RUEDAS / ESPUMAS  
DE 30KG HR

#### RESPALDOS



RECLINABLES  
CON FIBRA HUECA  
SILICONADA 100%

#### DE SERIE



PIES METÁLICOS  
DELANTEROS Y  
BRAZO DE SIESTA

# GIJÓN

		ALTO	FONDO	ANCHO	BULTOS	PLAZAS
	SOFÁ 3 PLAZAS (3 ASIENTOS) EXT. 275	1,07	1,03	2,75	2	3
	SOFÁ 2 PLAZAS (2 ASIENTOS) EXT. 202	1,07	1,03	2,02	1	2
	CONJUNTO 3 + 2 PLAZAS				3	5
	MOD. 3 PLAZAS (2 ASIENTOS + CHAISERLONGUE EXT. 275)	1,07	1,50	2,75	2	4

Tapizados  
Juan Díaz, S.L.

SOFÁ 2/3 PLAZAS  
CHAISERLONGUE



# “AROSA”

CHAISELONGUE



*Juan Diaz*

# “AROSA”

CHAISELONGUE



DETALLE SOFÀ ABIERTO

Juan Díaz

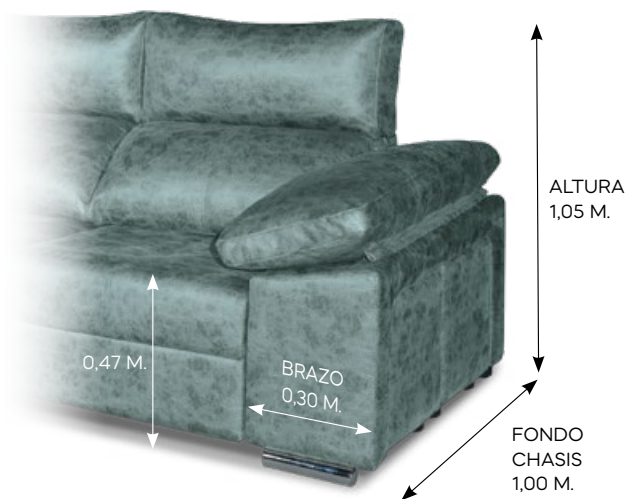

ASIENTOS DESLIZANTES DE CARROS



ARCÓN ABATIBLE EN LA CHAISELONGUE.



2 PUFFS LATERALES EN BRAZO.

### OBSERVACIONES

**IMPORTANTE! SE DEBE INDICAR LA MANO DE LOS CHAISELONGUE VISTOS DE FRENTE.**

#### ESTRUCTURA

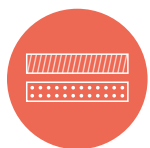

MADERA DE PINO MACIZO REFORZADA CON ESCUADRAS Y LATERALES CON AGLOMERADO DE ALTA RESISTENCIA.

#### ASIENTOS



DESLIZANTES METÁLICOS DE CARROS / ESPUMAS DE 30 KG. HR

#### RESPALDOS Y BRAZOS



RECLINABLES CON FIBRA HUECA SILICONADA 100%

#### DE SERIE



PIES METÁLICOS, PUFFS LATERALES Y ARCÓN EN LA CHAISELONGUE

# AROSA

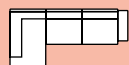

CHAISELONGUE 280 CARROS

ALTO	FONDO	ANCHO	BULTOS	PLAZAS
1,05	1,65	2,80	2	4

 Tapizados Juan Díaz, S.L.

CHAISELONGUE

# “BLUE”

SOFÁ 2/3 PLAZAS

CHAISELONGUE



*Juan Díaz*

# “BLUE”

CHASELONGUE



OPCIÓN SOFÁ 2/3 PLAZAS



OPCIÓN SOFÁ 2/3 PLAZAS ABIERTO



OPCIÓN CHASELONGUE

Juan Díaz



ASIENTOS DESLIZANTES  
CABEZALES RECLINABLES



PATA ALTA: IDEALES PARA QUE  
TRABAJE EL ROBOT DE LIMPIEZA.

### OBSERVACIONES

**IMPORTANTE! SE DEBE INDICAR LA MANO DE LOS CHAISLONGUE VISTOS DE FRENTE.**

#### ESTRUCTURA

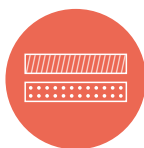

MADERA DE PINO MACIZO REFORZADA  
CON ESCUADRAS Y LATERALES CON  
AGLOMERADO DE ALTA RESISTENCIA.

#### ASIENTOS



DESLIZANTES  
METÁLICOS DE CARROS  
/ ESPUMAS DE 30KG HR.

#### RESPALDOS



RECLINABLES  
CON FIBRA HUECA  
SILICONADA 100%.

#### DE SERIE



PIES METÁLICOS  
CROMADOS O NEGROS Y  
BRAZO SIESTA.

# BLUE

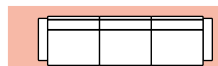

SOFÁ 3 PLAZAS (3 ASIENTOS) EXT. 280

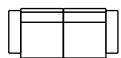

SOFÁ 2 PLAZAS (2 ASIENTOS) EXT. 207



MOD 3 PLAZAS 2 ASIENTOS + CHAISE - EXT. 280

	ALTO	FONDO	ANCHO	BULTOS	PLAZAS
SOFÁ 3 PLAZAS (3 ASIENTOS) EXT. 280	1,05	1,05	280	2	3
SOFÁ 2 PLAZAS (2 ASIENTOS) EXT. 207	1,05	1,05	207	1	2
MOD 3 PLAZAS 2 ASIENTOS + CHAISE - EXT. 280	1,05	1,65	280	2	4

Tapizados Juan Díaz, S.L.

SOFÁ 2/3 PLAZAS  
CHAISELONGUE

# “DUNA”

CHAISELONGUE

SOFÁ 2/3 PLAZAS



*Juan Díaz*

# “DUNA”

CHAISELONGUE



OPCIÓN SOFÁ 2/3 PLAZAS



DETALLE SOFÁ ABIERTO



Juan Díaz

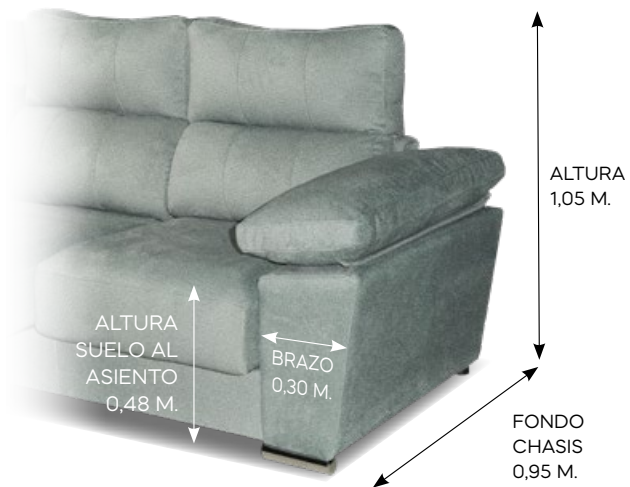

ASIENTOS DESLIZANTES  
CABEZALES RECLINABLES



ARCÓN ABATIBLE  
EN LA CHAISELONGUE.



OPCIÓN PATA ALTA:  
COMPUESTO POR 4 PATAS ALTAS METÁLICAS  
SEGÚN FOTO CATÁLOGO  
+ 1 PATA REDONDA + TORNILLERÍA

**OBSERVACIONES**

**IMPORTANTE! SE DEBE INDICAR LA MANO DE LOS CHAISELONGUE VISTOS DE FRENTE.**

**ESTRUCTURA**

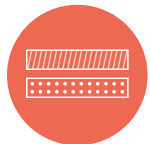

MADERA DE PINO MACIZO REFORZADA  
CON ESCUADRAS Y LATERALES CON  
AGLOMERADO DE ALTA RESISTENCIA.

**ASIENTOS**



ESPUMAS DE 30 KG. + ESPUMA 5CM  
25KG SUAVE. EXTRAIBLES DE RUEDAS  
CON FRENO PUNTO A PUNTO

**RESPALDOS**



CON FIBRA HUECA  
SILICONADA 100%

**DE SERIE**



PIES METÁLICOS DELANTEROS  
Y ARCÓN EN LA CHAISELONGUE

**DUNA**

		ALTO	FONDO	ANCHO	BULTOS	PLAZAS
	2 ASIENTOS EXT + CHAISELONGUE - 290	1,05	1,50	2,90	2	4
	2 ASIENTOS EXT. + CHAISELONGUE - 260	1,05	1,50	2,60	2	4
	2 ASIENTOS EXT. + CHAISELONGUE - 245	1,05	1,50	2,45	2	4
	SOFÁ 3 PLAZAS 2 ASIENTOS EXT. 210	1,05	0,95	2,10	1	3
	SOFÁ 2 PLAZAS 2 ASIENTOS EXT. 180	1,05	0,95	1,80	1	2
	CONJUNTO 3+2 PLAZAS EXT.	1,05	0,95		2	5
	SOFÁ 3 PLAZAS (3 ASIENTOS) EXT. 290	1,05	0,95	2,90	2	3
	SOFÁ 3 PLAZAS (3 ASIENTOS) EXT. 260	1,05	0,95	2,60	2	3
	SOFÁ 3 PLAZAS (3 ASIENTOS) EXT. 245	1,05	0,95	2,45	2	3
	PUFF REVERSIBLE 290 / 260 / 245	0,70	0,75	0,98	1	1

Tapizados Juan Díaz, S.L.

**SOFÁ 2/3 PLAZAS  
CHAISELONGUE**

# “BURNING”

SOFÁ 2/3 PLAZAS

CHAISELONGUE



*Juan Díaz*

# “BURNING”

SOFÁ 2 PLAZAS

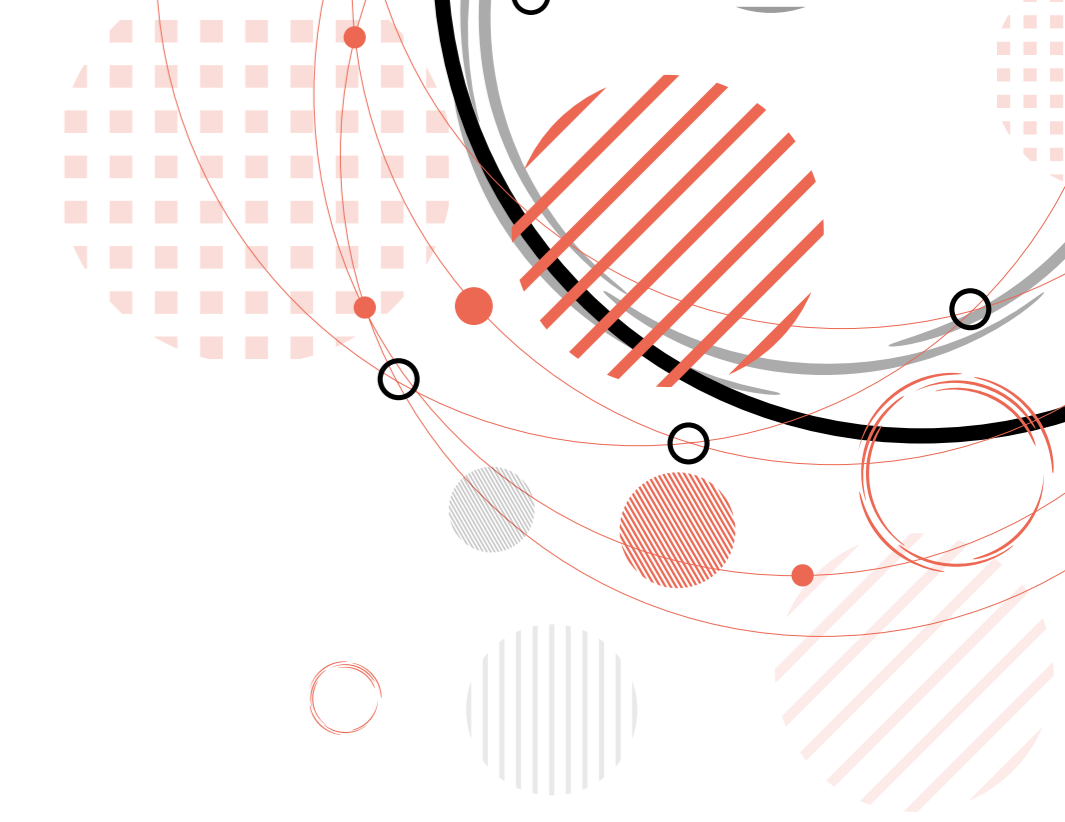

OPCIÓN CHAISELONGUE



DETALLE SOFÁ ABIERTO

Juan Díaz



ASIENTOS DESLIZANTES



OPCIÓN PATA ALTA:  
COMPUESTO POR 4 PATAS ALTAS METÁLICAS SEGÚN FOTO  
CATÁLOGO + 1 PATA REDONDA + TORNILLERÍA

### OBSERVACIONES

**IMPORTANTE! SE DEBE INDICAR LA MANO DE LOS CHAISERLONGUE VISTOS DE FRENTE.**

#### ESTRUCTURA

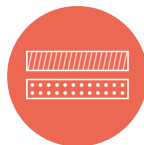

MADERA DE PINO MACIZO CON  
LATERALES DE CONTRACHAPADO DE  
19 MM, RECUBIERTA DE ESPUMA DE  
POLIURETANO DE 20 KG

#### ASIENTOS

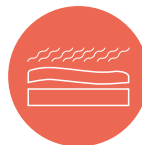

DESLIZANTES METÁLICOS  
CON COJINES DE ESPUMAS  
DE DENSIDAD 30KG

#### RESPALDOS Y BRAZOS



CON FIBRA HUECA  
SILICONADA 100%

# BURNING

		ALTO	FONDO	ANCHO	BULTOS	PLAZAS
	SOFÁ 3 PLAZAS (2 ASIENTOS) EXT. 200	1,04	0,92	2,00	1	3
	SOFÁ 2 PLAZAS (2 ASIENTOS) EXT. 180	1,04	0,92	1,80	1	2
	CONJUNTO 3 + 2 PLAZAS				2	5
	MOD. 3 PLAZAS (2 ASIENTOS + CHAISERLONGUE EXT. 280)	1,04	1,65	2,80	2	4

Tapizados  
Juan Díaz, S.L.

SOFÁ 2/3 PLAZAS  
CHAISERLONGUE

# “HIMALAYA”

SOFÁ 2/3 PLAZAS

CHAISELONGUE

RINCONERA



*Juan Díaz*

# “HIMALAYA”

RINCONERA



OPCIÓN SOFÁ 2/3 PLAZAS

Juan Díaz

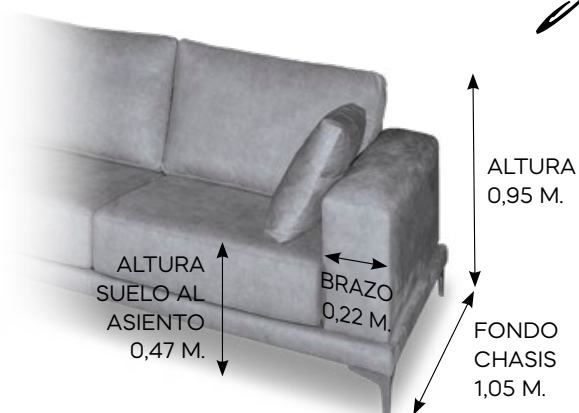

**PATA ALTA:** IDEALES PARA QUE TRABAJE EL ROBOT DE LIMPIEZA.

## OBSERVACIONES

**IMPORTANTE! SE DEBE INDICAR LA MANO DE LOS CHAISERLONGUE VISTOS DE FRENTE.**

### ESTRUCTURA

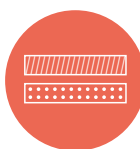

MADERA DE PINO MACIZO REFORZADA CON ESCUADRAS Y LATERALES CON AGLOMERADO DE ALTA RESISTENCIA

### ASIENTOS



FIJOS. ESPUMAS DE 32 KG. HR

### RESPALDOS



FIJOS CON FIBRA HUECA SILICONADA 100%

### DE SERIE



PIES METÁLICOS, COJINES DECORATIVOS

# HIMALAYA

		ALTO	FONDO	ANCHO	BULTOS	PLAZAS
	MODELO 3 PLAZAS (2 ASIENTOS FIJOS + CHAISERLONGUE) 290	0,95	1,05	2,90	2	4
	MODELO 2 PLAZAS (2 ASIENTOS FIJOS + CHAISERLONGUE) 260	0,95	1,05	2,60	2	4
	SOFÁ 3 PLAZAS (2 ASIENTOS) 210	0,95	1,01	2,10	1	3
	SOFÁ 2 PLAZAS (2 ASIENTOS) 190	0,95	1,01	1,90	1	2
	CONJUNTO 3 + 2 PLAZAS				2	5
	MÓDULO RINCÓN 105X105	0,95	1,05	1,05	1	1
	MÓDULO 1 PL. S/B	0,95	1,05	0,71/0,81	1	1
	MÓDULO 1 PL. C/B	0,95	1,05	0,95/1,05	1	1
	MÓDULO 2 PL. S/B	0,95	1,05	1,43	1	2
	MÓDULO 2 PL. C/B	0,95	1,05	1,60	1	2
	MÓDULO 3 PL. S/B	0,95	1,05	1,63	1	3
	MÓDULO 3 PL. C/B	0,95	1,05	1,85	1	3
	MÓDULO CHAISERLONGUE	0,95	1,58	1,05	1	2

Tapizados Juan Díaz, S.L.

SOFÁ 2/3 PLAZAS  
CHAISERLONGUE  
RINCONERA

# “REVER”

SOFÁ 2/3 PLAZAS

CHAISELONGUE



*Juan Díaz*



# “REVER”

CHAISELONGUE



DETALLE CHAISELONGUE ABIERTA

Juan Díaz

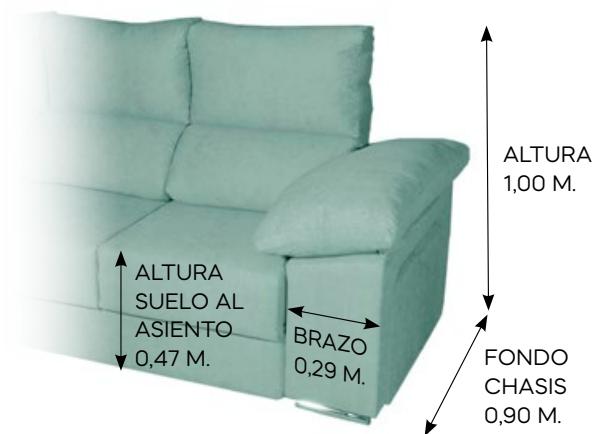

ASIENTOS DESLIZANTES  
CABEZALES RECLINABLES



2 PUFFS  
EXTRAÍBLES

### OBSERVACIONES

**IMPORTANTE! SE DEBE INDICAR LA MANO DE LOS CHAISELONGUE VISTOS DE FRENTE.**

#### ESTRUCTURA

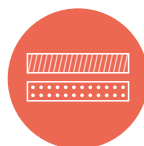

MADERA DE PINO MACIZO REFORZADA  
CON ESCUADRAS Y LATERALES CON  
AGLOMERADO DE ALTA RESISTENCIA

#### ASIENTOS



DESLIZANTES PUNTO A  
PUNTO / ESPUMAS  
DE 30 KG. SUAVE

#### RESPALDOS Y BRAZOS



CABEZALES RECLINABLES,  
FIBRA HUECA 100%  
SILICONADA

# REVER

		ALTO	FONDO	ANCHO	BULTOS	PLAZAS
	CHAIS REVERSIBLE 240 EXT. PUFFS LATERALES	1,00	1,50	2,40	2	4
	CHAIS REVERSIBLE 270 EXT. PUFFS LATERALES	1,10	1,50	2,70	2	4
	SOFÁ 3 PLAZAS 3 ASIENTOS EXT. 240 PUFFS LATERALES	1,00	0,90	2,40	2	3
	SOFÁ 3 PLAZAS 3 ASIENTOS EXT. 270 PUFFS LATERALES	1,00	0,90	2,70	2	3
	SOFÁ 2 PLAZAS 2 ASIENTOS EXT. 180 PUFFS LATERALES	1,00	0,90	1,80	2	2
	PUFF REVERSIBLE 240 / 270	0,45	0,87	0,61 / 0,71	1	1
	CONJUNTO 3 PLAZAS 240 + 3 PLAZAS 180				4	5

Tapizados  
Juan Díaz, S.L.

SOFÁ 2/3 PLAZAS  
CHAISELONGUE

# “TALISMÁN”

SOFÁ 2/3 PLAZAS

CHAISELONGUE

RINCONERA



*Juan Díaz*

# “TALISMÁN”

RINCONERA



DETALLE RINCONERA ABIERTA



OPCIÓN CHAISELONGUE ABIERTA



OPCIÓN SOFÁ 2/3 PLAZAS

Juan Díaz

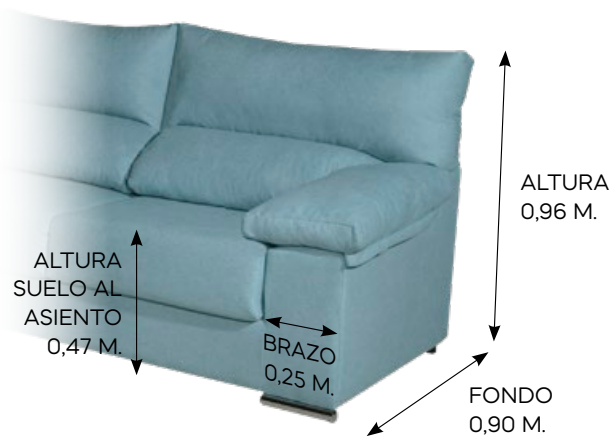

ASIENTOS DESLIZANTES  
CABEZALES RECLINABLES



OPCIÓN PATA ALTA: COMPUESTO POR 4 PATAS ALTAS METÁLICAS  
SEGÚN FOTO CATÁLOGO + 1 PATA REDONDA + TORNILLERÍA

**OBSERVACIONES**

**IMPORTANTE! SE DEBE INDICAR LA MANO DE LOS CHAISELONGUE VISTOS DE FRENTE.**

**ESTRUCTURA**

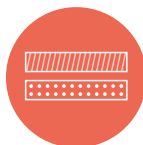

MADERA DE PINO MACIZO REFORZADA CON ESCUADRAS Y LATERALES CON AGLOMERADO DE ALTA RESISTENCIA.

**ASIENTOS**

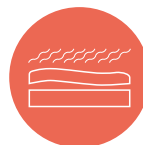

ASIENTOS DESLIZANTES PUNTO A PUNTO / ESPUMAS DE 30KG SUAVE.

**RESPALDOS Y BRAZOS**



CABEZALES RECLINABLES, FIBRA HUECA 100% SILICONADA.

# TALISMÁN

		ALTO	FONDO	ANCHO	BULTOS	PLAZAS
	SOFA 3 PLAZAS (2 ASIENTOS) EXT. 195	0,96	0,90	1,95	1	3
	SOFA 2 PLAZAS (2 ASIENTOS) EXT. 165	0,96	0,90	1,65	1	2
	CONJUNTO 3 + 2 EXT.	0,96	0,90		2	5
	MOD. 2 PLAZAS 2 ASIENTOS + CHAISE LONGUE - EXT. 270	0,96	1,45	2,70	2	4
	MOD. 3 PLAZAS 2 ASIENTOS EXT. + CHAISE LONGUE - EXT. 225	0,96	1,45	2,25	2	4
	MÓDULO 1 PLAZA EXT. C/B. 0,86 / 0,96	0,96	0,95	0,86/0,96	1	1
	MÓDULO 1 PLAZA EXT. S/B. 0,63 / 0,73	0,96	0,90	0,63/0,73	1	1
	MÓDULO 2/PLAZAS EXT. C/B 149	0,96	0,90	1,49	1	2
	MÓDULO 2/PLAZAS EXT. S/B 126	0,96	0,90	1,26	1	2
	MÓDULO 3/PLAZAS EXT. C/B 169	0,96	0,90	1,69	1	3
	MÓDULO 3/PLAZAS EXT. S/B 146	0,96	0,90	1,46	1	3
	MÓDULO RINCÓN	0,96	0,90	0,95	1	1
	MÓDULO CHAISE LONGUE	0,96	1,45	1,01	1	2

Tapizados Juan Díaz, S.L.

SOFÁ 2/3 PLAZAS  
CHAISELONGUE  
RINCONERA

# “MILÁN”

CHAISELONGUE



*Juan Díaz*

# “MILÁN”

CHAISELONGUE



DETALLE CHAISELONGUE ABIERTA

Juan Díaz

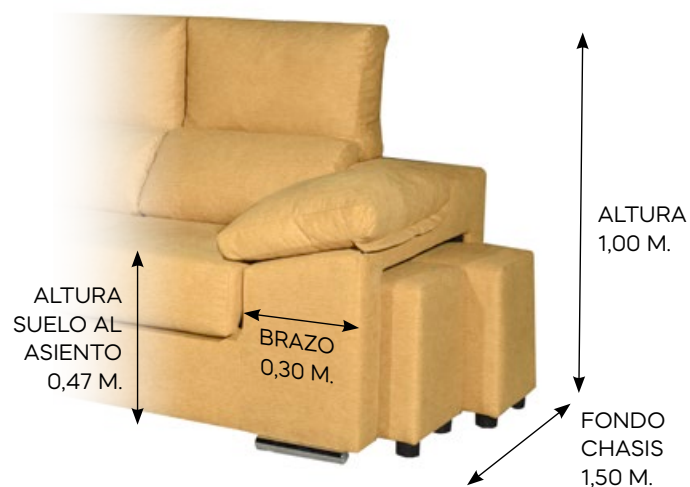

PUFFS LATERALES  
CABEZALES RECLINABLES



ASIENTOS DESLIZANTES



ARCÓN ABATIBLE

OBSERVACIONES

**IMPORTANTE! SE DEBE INDICAR LA MANO DE LOS CHAISELONGUE VISTOS DE FRENTE.**

ESTRUCTURA

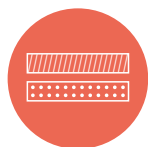

MADERA DE PINO MACIZO REFORZADA CON ESCUADRAS Y LATERALES CON AGLOMERADO DE ALTA RESISTENCIA

ASIENTOS



ASIENTOS DESLIZANTES / ESPUMAS DE 25 KG SUAVE

RESPALDOS



RECLINABLES CON FIBRA 100% SILICONADA

DE SERIE



PUFFS LATERALES, ARCÓN EN LA CHAISELONGUE Y BRAZOS SIESTA

MILÁN

		ALTO	FONDO	ANCHO	BULTOS	PLAZAS
	MOD 2 PLAZAS (2 ASIENTOS + CHAISELONGUE - EXT. 230)	1,00	1,50	2,30	2	4
	MOD 3 PLAZAS (2 ASIENTOS + CHAISELONGUE - EXT. 260)	1,00	1,50	2,60	2	4

Tapizados Juan Díaz, S.L.

CHAISELONGUE





“ 9 ~~○~~ ~~○~~ ”

SOFÁ 2/3 PLAZAS

CHAISELONGUE

SOFÁ CAMA

RINCONERA



*Juan Díaz*

“ 9 0 0 ”

SOFA 2 PLAZAS



OPCIÓN RINCONERA

Juan Díaz

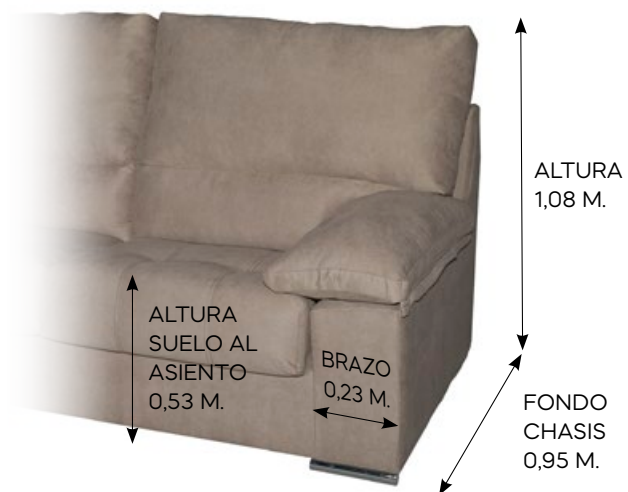

OPCIÓN PATA ALTA (EXCEPTO CUANDO LLEVA CAMA):  
 COMPUESTO POR 4 PATAS ALTAS METÁLICAS SEGÚN FOTO  
 CATÁLOGO + 1 PATA REDONDA + TORNILLERÍA

OBSERVACIONES

**IMPORTANTE! SE DEBE INDICAR LA MANO DE LOS CHAISELONGUE VISTOS DE FRENTE.**

ESTRUCTURA

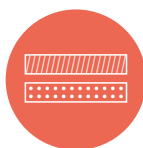

MADERA DE PINO MACIZO REFORZADA CON ESCUADRAS Y  
 LATERALES CON AGLOMERADO DE ALTA RESISTENCIA

ASIENTOS



ESPUMAS DE 30KG HR  
 Y MUELLE ZIG-ZAG

RESPALDOS



FIBRA HUECA  
 SILICONADA 100%

DE SERIE



COLCHÓN  
 135X180 CM.



		ALTO	FONDO	ANCHO	BULTOS	PLAZAS
	SOFÁ 3 PLAZAS (2 ASIENTOS) 195	1,08	0,95	1,95	1	3
	SOFÁ 2 PLAZAS (2 ASIENTOS) 165	1,08	0,95	1,65	1	2
	CONJUNTO 3 + 2 PLAZAS				2	5
	SOFÁ 3 PLAZAS - CAMA COLCHÓN 135X180	1,08	0,95	1,95	1	3
	CHAISELONGUE (2 ASIENTOS + CHAISE) 270	1,08	1,50	2,70	2	4
	CHAISELONGUE (2 ASIENTOS + CHAISE) 225	1,08	1,50	2,25	2	4
	MÓDULO 1 PLAZA C/B 0,86/0,96	1,08	0,95	0,86/0,96	1	1
	MÓDULO 1 PLAZA S/B 0,63/0,73	1,08	0,95	0,63/0,73	1	1
	MÓDULO 2 PLAZAS C/B 149	1,08	0,95	1,49	1	2
	MÓDULO 2 PLAZAS S/B 126	1,08	0,95	1,26	1	2
	MÓDULO 3 PLAZAS C/B 169	1,08	0,95	1,69	1	3
	MÓDULO 3 PLAZAS S/B 146	1,08	0,95	1,46	1	3
	MÓDULO RINCÓN	1,08	0,95	0,95	1	1
	MÓDULO CHAISELONGUE	1,08	1,50	1,01	1	2

Tapizados Juan Díaz, S.L.

SOFÁ 2/3 PLAZAS  
 CHAISELONGUE  
 SOFÁ CAMA  
 RINCONERA

“950”

SOFÁ 2/3 PLAZAS

CHAISELONGUE

SOFÁ CAMA



*Juan Díaz*



“950”

SOFÁ 3 PLAZAS



OPCIÓN SOFÁ 2 PLAZAS

Juan Díaz

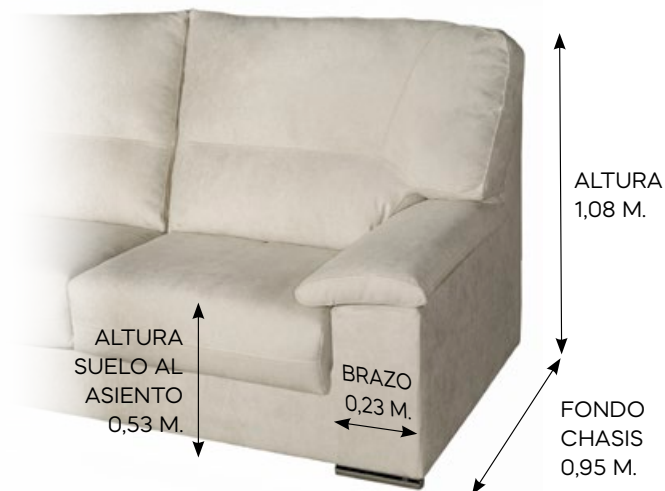

**OPCIÓN PATA ALTA (EXCEPTO CUANDO LLEVA CAMA):**  
 COMPUESTO POR 4 PATAS ALTAS METÁLICAS SEGÚN FOTO  
 CATÁLOGO + 1 PATA REDONDA + TORNILLERÍA

### OBSERVACIONES

**IMPORTANTE! SE DEBE INDICAR LA MANO DE LOS CHAISLONGUE VISTOS DE FRENTE.**

#### ESTRUCTURA

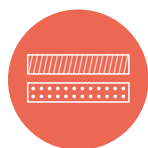

MADERA DE PINO MACIZO REFORZADA  
 CON ESCUADRAS Y LATERALES CON  
 AGLOMERADO DE ALTA RESISTENCIA

#### ASIENTOS



ESPUMAS DE 30KG HR  
 Y MUELLE ZIG-ZAG

#### RESPALDOS



FIBRA HUECA  
 SILICONADA 100%

#### DE SERIE



COLCHÓN  
 135X180 CM.

950

		ALTO	FONDO	ANCHO	BULTOS	PLAZAS
	SOFA 3 PLAZAS (2 ASIENTOS) 190	1,08	0,95	1,95	1	3
	SOFA 2 PLAZAS (2 ASIENTOS) 165	1,08	0,95	1,65	1	2
	CONJUNTO 3+2				2	5
	SOFA 3 PLAZAS - CAMA 135X180	1,08	0,95	1,95	1	3
	CHAISLONGUE (2 ASIENTOS + CHAISE) 225	1,08	1,50	2,25	2	4
	CHAISLONGUE (2 ASIENTOS + CHAISE) 270	1,08	1,50	2,70	2	4

Tapizados Juan Díaz, S.L.

SOFA 2/3 PLAZAS  
 CHAISLONGUE



# “TURÍN”

SOFÁ 2/3 PLAZAS

CHAISELONGUE

*Juan Díaz*

# "TURÍN"

CHAISELONGUE



OPCIÓN SOFÁ 3 ASIENTOS



Juan Díaz

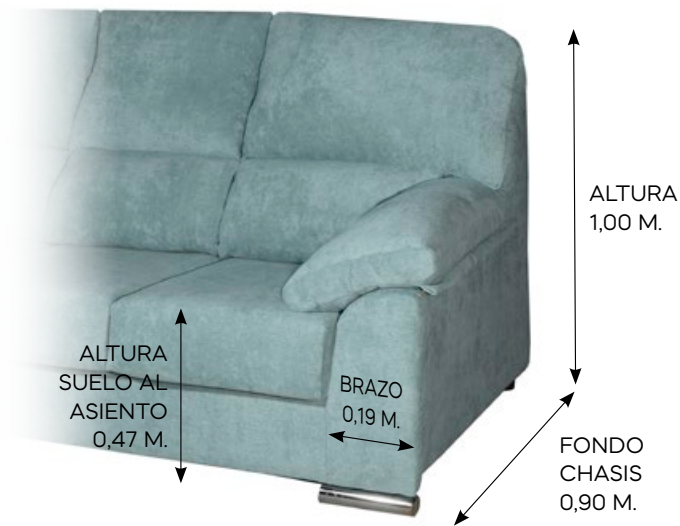

**OPCIÓN PATA ALTA:** COMPUESTO POR 4 PATAS ALTAS METÁLICAS SEGÚN FOTO CATÁLOGO + 1 PATA REDONDA + TORNILLERÍA

### OBSERVACIONES

**IMPORTANTE! SE DEBE INDICAR LA MANO DE LOS CHAISLONGUE VISTOS DE FRENTE.**

#### ESTRUCTURA

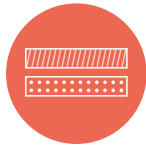

MADERA DE PINO MACIZO REFORZADA CON ESCUADRAS Y LATERALES CON AGLOMERADO DE ALTA RESISTENCIA.

#### ASIENTOS

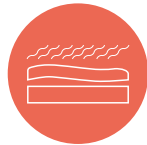

ASIENTOS FIJOS DESENFUNDABLES / ESPUMAS DE 25KG.

#### RESPALDOS Y BRAZOS



DESENFUNDABLES, FIBRA HUECA 100% SILICONADA.

#### DE SERIE



PIES METÁLICOS

# TURÍN

		ALTO	FONDO	ANCHO	BULTOS	PLAZAS
	CHAIS REVERSIBLE 200	1,00	1,45	2,00	2	3
	CHAIS 250	1,00	1,45	2,50	2	4
	SOFÁ 3 PLAZAS 2 ASIENTOS	1,00	0,90	1,80	1	3
	SOFÁ 2 PLAZAS 2 ASIENTOS	1,00	0,90	1,50	1	2
	CONJUNTO 3+2				2	5
	SOFÁ 3 PLAZAS 3 ASIENTOS 200	1,00	0,90	2,00	1	3
	PUFF REVERSIBLE	0,50	0,57	0,70	1	1

**Juan Díaz, S.L.**

**SOFÁ 2/3 PLAZAS CHAISLONGUE**

# “VILLA”

SOFÁ 2/3 PLAZAS FIJO/CAMA

CHAISELONGUE FIJO/CAMA



*Juan Díaz*

# “VILLA”

SOFÁ 3 PLAZAS



OPCIÓN SOFÁ 2 PLAZAS



OPCIÓN CHAISELONGUE REVERSIBLE



OPCIÓN CAMA ABIERTA

Juan Díaz

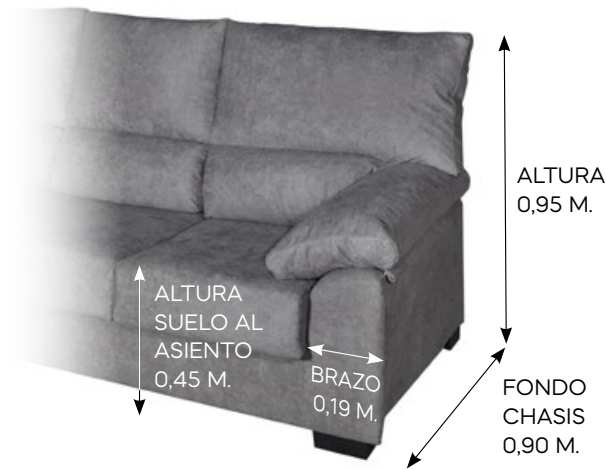

OPCIÓN PATA ALTA (EXCEPTO CUANDO LLEVA CAMA):  
 COMPUESTO POR 4 PATAS ALTAS METÁLICAS SEGÚN FOTO  
 CATÁLOGO + 1 PATA REDONDA + TORNILLERÍA



### OBSERVACIONES

**IMPORTANTE! SE DEBE INDICAR LA MANO DE LOS CHAISELONGUE VISTOS DE FRENTE.**

#### ESTRUCTURA

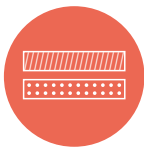

MADERA DE PINO MACIZO REFORZADA CON ESCUADRAS Y LATERALES CON AGLOMERADO DE ALTA RESISTENCIA.

#### ASIENTOS

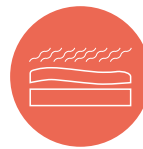

ESPUMAS DE DENSIDAD 25 KG,  
 RECUBIERTO DE GUATA.

#### RESPALDOS Y BRAZOS



CON INTERIOR DE MEZCLA DE FIBRA  
 Y PICADO. DESENFUNDABLE.

## VILLA

		ALTO	FONDO	ANCHO	BULTOS	PLAZAS
	SOFÁ 3 PLAZAS (2 ASIENTOS) 180	0,95	0,90	1,80	1	3
	SOFÁ 2 PLAZAS (2 ASIENTOS) 150	0,95	0,90	1,50	1	2
	CONJUNTO 3 + 2				2	5
	SOFÁ 3 PLAZAS (2 ASIENTOS) CAMA HR 120X180	0,95	0,90	1,80	1	3
	SOFÁ 3 PLAZAS (3 ASIENTOS) CAMA HR 135X180	0,95	0,90	2,00	1	3
	CHAISELONGUE 200 REVERSIBLE CAMA 135	0,95	1,45	2,00	2	3
	CHAISELONGUE (2 ASIENTOS+CHAISE) 250	0,95	1,45	2,50	2	4
	CHAISELONGUE 2.00 REVERSIBLE	0,95	1,45	2,00	1	3
	SOFÁ 3 PLAZAS (3 ASIENTOS) 200	0,95	0,90	2,00	1	3
	PUFF REVERSIBLE	0,55	0,57	0,70	1	1

Juan Díaz, S.L.

SOFÁ 2/3 PLAZAS  
 FIJO/CAMA

CHAISELONGUE  
 FIJO/CAMA

# “VALEY”

SOFÁ 2/3 PLAZAS

PUFF REVERSIBLE



*Juan Díaz*

# “VALEY”

SOFÁ 3 PLAZAS

PUFF REVERSIBLE



OPCIÓN SOFÁ 3 PLAZAS

Juan Díaz

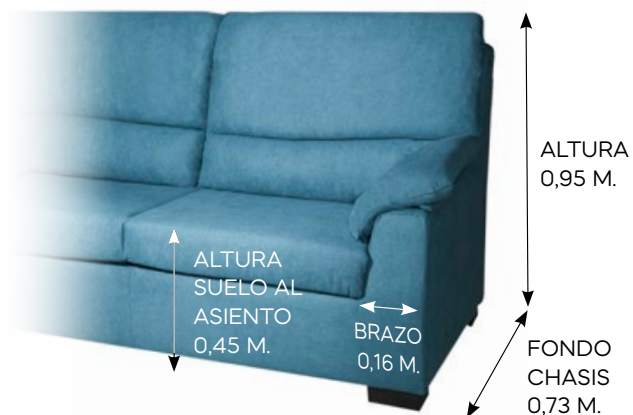

PUFF REVERSIBLE



OPCIÓN PATA ALTA: COMPUESTO POR 4 PATAS ALTAS METÁLICAS SEGÚN FOTO CATÁLOGO + 1 PATA REDONDA + TORNILLERÍA

### ESTRUCTURA

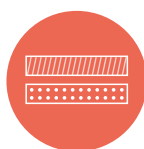

MADERA DE PINO MACIZO REFORZADA CON ESCUADRAS Y LATERALES CON AGLOMERADO DE ALTA RESISTENCIA

### ASIENTOS



ESPUMAS DE DENSIDAD 25 KG, RECUBIERTO DE GUATA

### RESPALDOS Y BRAZOS



CON INTERIOR DE MEZCLA DE FIBRA Y PICADO. DESENFUNDABLE

## VALEY

		ALTO	FONDO	ANCHO	BULTOS	PLAZAS
	SOFÁ 3 PLAZAS (2 ASIENTOS) 175	0,95	0,73	1,75	1	3
	SOFÁ 2 PLAZAS (2 ASIENTOS) 135	0,95	0,73	1,35	1	2
	CONJUNTO 3 + 2 PLAZAS				2	5
	SOFÁ 3 PLAZAS (3 ASIENTOS)	0,95	0,75	1,75	1	3
	PUFF REVERSIBLE	0,55	0,55	0,55	1	1

Tapizados Juan Díaz, S.L.

SOFÁ 2/3 PLAZAS  
PUFF REVERSIBLE

A man with a beard and short hair, wearing a light-colored button-down shirt and jeans, is sitting on a sofa. He is looking down at a laptop computer that is open on his lap. The sofa is a dark grey color with two cushions. The background is a plain, light-colored wall.

# “CAMA ITALIANA”

**SOFA-CAMA**  
SISTEMA APERTURA ITALIANO

*Juan Diaz*



# “CAMA ITALIANA”

SOFÁ CAMA



DETALLE SOFÁ-CAMA ABIERTO

Juan Díaz

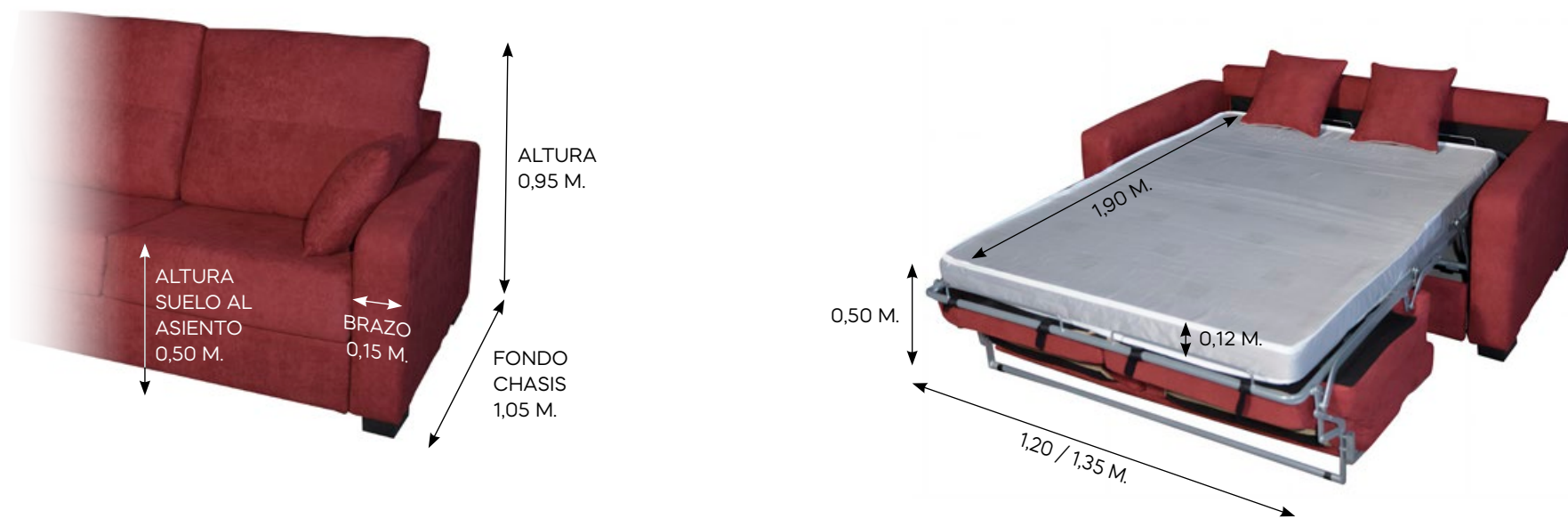

#### ESTRUCTURA

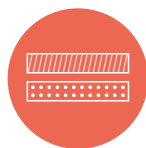

MADERA DE PINO MACIZO REFORZADA CON ESCUADRAS Y LATERALES CON AGLOMERADO DE ALTA RESISTENCIA

#### ASIENTOS



ESPUMAS DE DENSIDAD 25 KG, RECUBIERTO DE GUATA

#### RESPALDOS Y BRAZOS



INTERIOR DE MEZCLA DE FIBRA Y PICADO. DESENFUNDABLE

#### DE SERIE



SISTEMA CAMA ITALIANO Y COLCHÓN

# CAMA ITALIANA

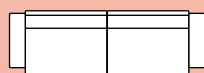

SOFÁ 3 PL. (2 ASIENTOS). CAMA 135X180 ABIERTO TOTAL +/- 210



SOFÁ 2 PL. (2 ASIENTOS). CAMA 120X180 ABIERTO TOTAL +/- 210

ALTO	FONDO	ANCHO	BULTOS	PLAZAS
0,95	1,05/2,10	1,85	2	3
0,95	1,05/2,10	1,70	2	2

 *Tapizados* Juan Díaz, S.L.

SOFÁ-CAMA  
SISTEMA APERTURA ITALIANO

# “FLAX”

CHAISELONGUE-CAMA  
SISTEMA APERTURA ITALIANO

SOFÁ-CAMA  
SISTEMA APERTURA ITALIANO



*Juan Díaz*

“FLAX”

CHAISELONGUE-CAMA



DETALLE CHAISELONGUE-CAMA ABIERTO



OPCIÓN SOFÁ-CAMA



DETALLE SOFÁ-CAMA ABIERTO

Juan Díaz



ARCÓN EN AMBOS BRAZOS



OBSERVACIONES

**IMPORTANTE! SE DEBE INDICAR LA MANO DE LOS CHAISLONGUE VISTOS DE FRENTE.**

ESTRUCTURA

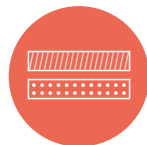

MADERA DE PINO MACIZO REFORZADA CON ESCUADRAS Y LATERALES CON AGLOMERADO DE ALTA RESISTENCIA.

ASIENTOS



ESPUMAS DENSIDAD 30 KG.

RESPALDOS Y BRAZOS



FIBRA HUECA SILICONADA 100%.

DE SERIE



SISTEMA CAMA ITALIANO 140X190X15 CM. Y ARCONES EN BRAZOS.

FLAX

	ALTO	FONDO	ANCHO	BULTOS	PLAZAS
 SOFÁ 3 PLAZAS SIST. APERTURA ITALIANO COLCHÓN 140X190X15 CM.	1,10	100	2,15	2	3



CHAISELONGUE SIST. APERTURA ITALIANO COLCHÓN 140X190X15 CM.

1,10	1,65	3,00	2	4
------	------	------	---	---



CHAISELONGUE-CAMA  
SISTEMA APERTURA ITALIANO  
SOFÁ-CAMA  
SISTEMA APERTURA ITALIANO

# “URBAN”

**SOFÁ-CAMA**

SISTEMA APERTURA ITALIANO



*Juan Díaz*

# “URBAN”

SOFÁ CAMA



DETALLE SOFÁ-CAMA ABIERTO

Juan Díaz

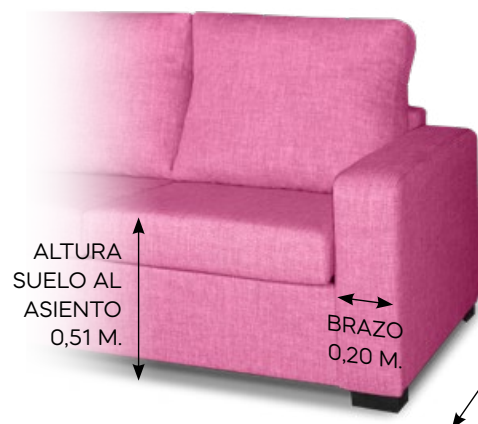

**ESTRUCTURA**

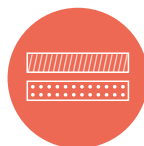

MADERA DE PINO MACIZO REFORZADA CON ESCUADRAS Y LATERALES CON AGLOMERADO DE ALTA RESISTENCIA

**ASIENTOS**

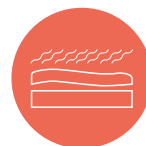

ESPUMAS DE DENSIDAD 30 KG,

**RESPALDOS**



FIBRA HUECA SILICONADA 100%

**DE SERIE**



SISTEMA CAMA ITALIANO Y COLCHÓN

URBAN

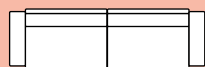

SOFÁ CAMA ITALIANO 140 X 190 X 15CM.

ALTO	FONDO	ANCHO	BULTOS	PLAZAS
1,10	1,00	2,05	2	3

 *Tapizados* Juan Díaz, S.L.

SOFÁ-CAMA SISTEMA APERTURA ITALIANO



# “ROMA”

CHAISELONGUE CAMA

SOFÁ CAMA



*Juan Díaz*

# “ROMA”

CHAISELONGUE CAMA



DETALLE CHAISE CAMA ABIERTA

Juan Díaz

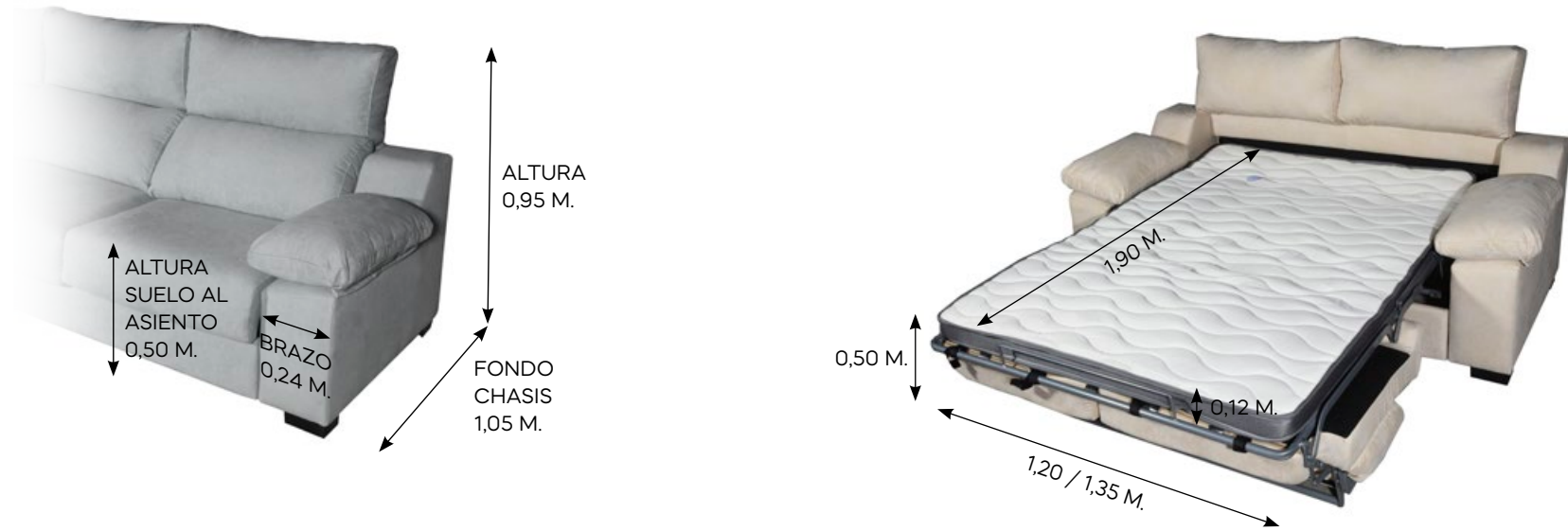

### OBSERVACIONES

**IMPORTANTE! SE DEBE INDICAR LA MANO DE LOS CHAISERLONGUE VISTOS DE FRENTE.**

#### ESTRUCTURA

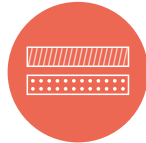

MADERA DE PINO MACIZO REFORZADA CON ESCUADRAS Y LATERALES CON AGLOMERADO DE ALTA RESISTENCIA

#### ASIENTOS

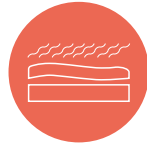

ESPUMAS DE DENSIDAD 30 KG.

#### RESPALDOS Y BRAZOS



FIBRA HUECA 100% SILICONADA

#### DE SERIE



SISTEMA CAMA ITALIANO

# ROMA

		ALTO	FONDO	ANCHO	BULTOS	PLAZAS
	MOD 3PL (2 ASIENTOS + CHAISERLONGUE 290)	1,05	1,65	2,90	2	4
	MOD 3PL (2 ASIENTOS + CHAISERLONGUE 270)	1,05	1,65	2,70	2	4
	SOFÁ CAMA 135 (2 ASIENTOS) 215	1,05	0,95	2,15	2	3
	SOFÁ CAMA 120 (2 ASIENTOS) 200	1,05	0,95	2,00	2	2

Tapizados Juan Díaz, S.L.

CHAISERLONGUE CAMA  
SOFÁ CAMA

# “MILKA”

SILLÓN RELAX PALANCA

SILLÓN RELAX ELÉCTRICO / POWER LIFT

SOFÁ 2/3 PLAZAS



*Juan Díaz*

# “MILKA”

SOFÁ 3 PLAZAS + SILLÓN RELAX

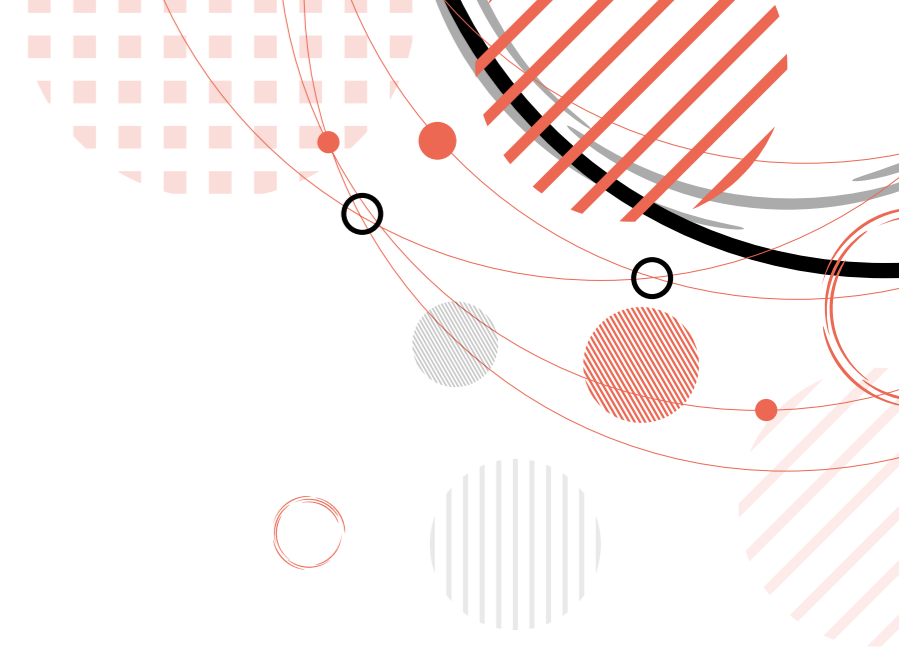

DETALLE RELAX ABIERTO



OPCIÓN POWER LIFT

Juan Díaz

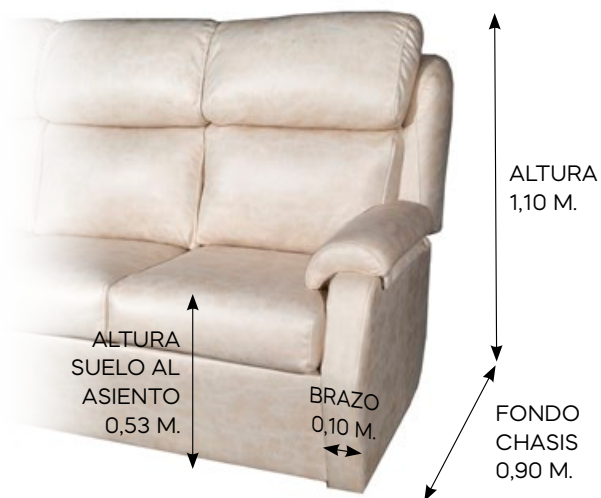

MECANISMO RELAX



OPCIÓN POWER LIFT

**ESTRUCTURA**

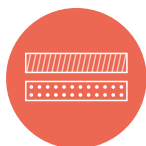

MADERA DE PINO MACIZO,  
CUBIERTO DE ESPUMA  
DENSIDAD 30 KG.

**ASIENTOS**

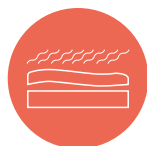

ESPUMAS DE  
DENSIDAD 30 KG.  
DESENFUNDABLE.

**RESPALDOS**



FIBRA HUECA  
SILICONADA 100%,  
DESENFUNDABLE.

**MECANISMOS**



PALANCA / ELECTRICO Y POWER LIFT  
SUBIÑAS SOLAMENTE EN LOS SILLONES,  
LOS SOFÁS DE 3 Y 2 PLAZAS SON FIJOS.

MILKA

		ALTO	FONDO	ANCHO	BULTOS	PLAZAS
	SILLÓN RELAX PALANCA	1,10	0,90	0,82	1	1
	SILLÓN RELAX ELÉCTRICO	1,10	0,90	0,82	1	1
	SILLÓN RELAX POWER LIFT	1,10	0,90	0,82	1	1
	SOFÁ 3 PLAZAS 3 ASIENTOS FIJO	1,10	0,90	1,95	1	3
	SOFÁ 2 PLAZAS 2 ASIENTOS FIJO	1,10	0,90	1,35	1	2

Tapizados Juan Díaz, S.L.

SILLÓN RELAX PALANCA

SILLÓN RELAX  
ELÉCTRICO / POWER LIFT

SOFÁ 2/3 PLAZAS

# “NELA”

SILLÓN RELAX PALANCA

SILLÓN RELAX ELÉCTRICO / POWER LIFT

SOFÁ 2/3 PLAZAS



*Juan Díaz*

# “NELA”

SOFÁ 3 PLAZAS + SILLÓN RELAX



DETALLE RELAX ABIERTO



OPCIÓN POWER LIFT



Juan Díaz

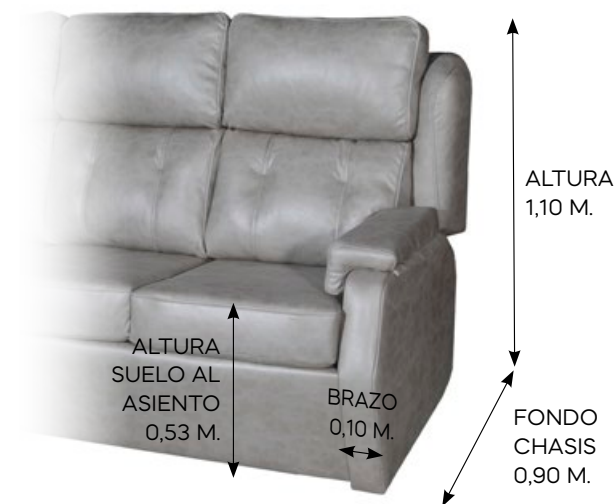

MECANISMO RELAX



OPCIÓN POWER LIFT

### ESTRUCTURA

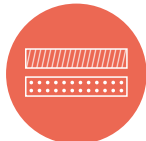

MADERA DE PINO MACIZO,  
CUBIERTO DE ESPUMA  
DENSIDAD 30 KG.

### ASIENTOS

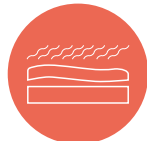

ESPUMAS DE  
DENSIDAD 30 KG.  
DESENFUNDABLE.

### RESPALDOS



FIBRA HUECA  
SILICONADA 100%,  
DESENFUNDABLE.

### MECANISMOS



PALANCA / ELECTRICO Y POWER LIFT  
SUBIÑAS SOLAMENTE EN LOS SILLONES,  
LOS SOFAS DE 3 Y 2 PLAZAS SON FIJOS.

# NELA

		ALTO	FONDO	ANCHO	BULTOS	PLAZAS
	SILLÓN RELAX PALANCA	1,10	0,90	0,82	1	1
	SILLÓN RELAX ELÉCTRICO	1,10	0,90	0,82	1	1
	SILLÓN RELAX POWER LIFT	1,10	0,90	0,82	1	1
	SOFÁ 3 PLAZAS 3 ASIENTOS FIJO	1,10	0,90	1,95	1	3
	SOFÁ 2 PLAZAS 2 ASIENTOS FIJO	1,10	0,90	1,35	1	2

**Juan Díaz, S.L.**

SILLÓN RELAX PALANCA

SILLÓN RELAX  
ELÉCTRICO / POWER LIFT

SOFÁ 2/3 PLAZAS

# “JÚCAR”

SOFÁ 2/3 PLAZAS

SILLÓN



*Juan Díaz*

# “JÚCAR”

SOFÁ 3 PLAZAS

SILLÓN



OPCIÓN SILLÓN



Juan Díaz

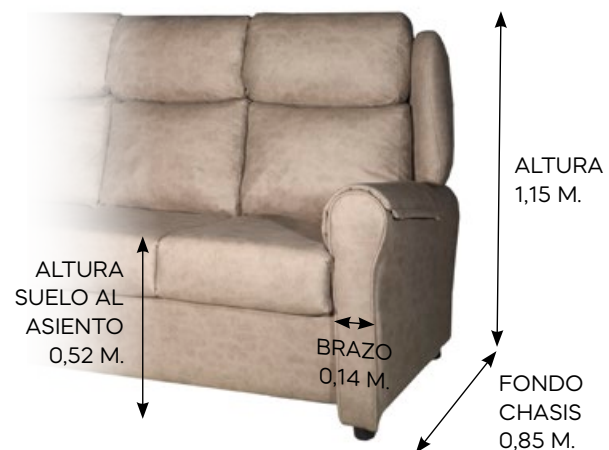

### ESTRUCTURA

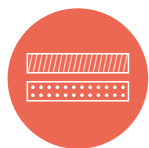

MADERA DE PINO MACIZO,  
CUBIERTO DE ESPUMA  
DENSIDAD 20 KG

### ASIENTOS

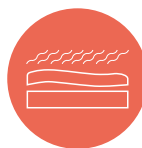

ESPUMAS DE  
DENSIDAD 25 KG,  
RECUBIERTO DE GUATA

### RESPALDOS



INTERIOR DE MEZCLA  
FIBRA Y PICADO,  
DESENFUNDABLE

# JÚCAR

		ALTO	FONDO	ANCHO	BULTOS	PLAZAS
	SOFÁ 3 PLAZAS (3 ASIENTOS) 180	1,15	0,85	1,80	1	3
	SOFÁ 2 PLAZAS (2 ASIENTOS) 130	1,15	0,85	1,30	1	2
	SILLÓN (1 PLAZA) 80	1,15	0,85	0,80	1	1

 **Juan Díaz, S.L.**

**SOFÁ 2/3 PLAZAS**  
**SILLÓN**

# “EBRO”

SOFÁ 2/3 PLAZAS

SILLÓN RELAX MANUAL



*Juan Díaz*

# “EBRO”

SOFÁ 3 PLAZAS

SILLÓN RELAX MANUAL



SILLÓN RELAX MANUAL

Juan Díaz

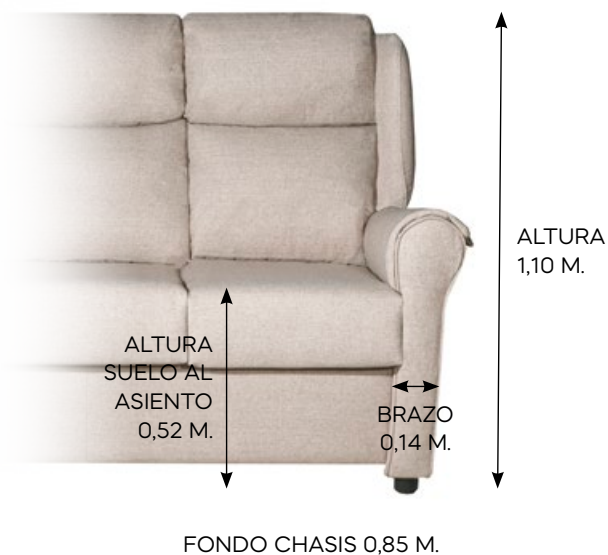

SILLÓN RELAX MANUAL

**ESTRUCTURA**

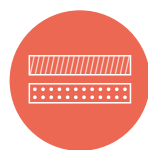

MADERA DE PINO MACIZO,  
CUBIERTO DE ESPUMA  
DENSIDAD 20 KG

**ASIENTOS**

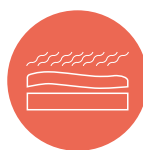

ESPUMAS DE  
DENSIDAD 25 KG,  
RECUBIERTO DE GUATA

**RESPALDOS**



INTERIOR DE MEZCLA  
FIBRA Y PICADO,  
DESENFUNDABLE

EBRO

		ALTO	FONDO	ANCHO	BULTOS	PLAZAS
	SOFÁ 3 PLAZAS (3 ASIENTOS) EXT. 180	1,10	0,85	1,80	1	3
	SOFÁ 2 PLAZAS (2 ASIENTOS) EXT. 130	1,10	0,85	1,30	1	2
	SILLÓN (1 PLAZA) EXT. 80 - RELAX	1,10	0,85	0,80	1	1

Tapizados Juan Díaz, S.L.

SOFÁ 2/3 PLAZAS  
SILLÓN RELAX MANUAL

# “DUERO”

SOFÁ 2/3 PLAZAS

SILLÓN



*Juan Díaz*



# “DUERO”

SOFÁ 3 PLAZAS

SILLÓN



OPCIÓN SILLÓN

Juan Díaz

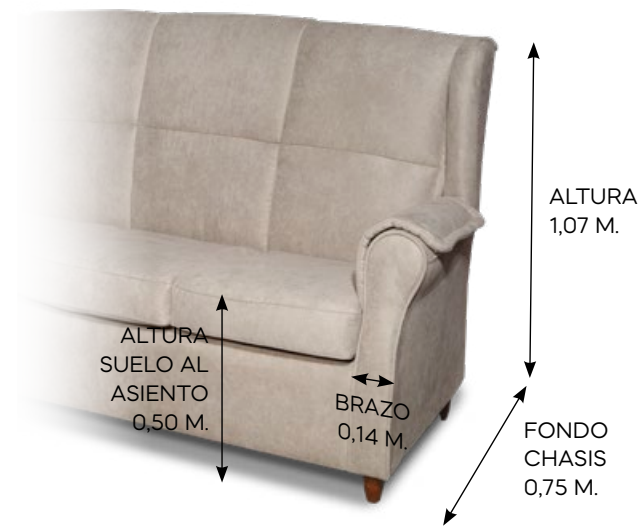

**ESTRUCTURA**

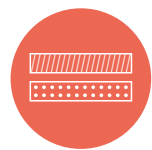

MADERA DE PINO MACIZO,  
CUBIERTO DE ESPUMA  
DENSIDAD 20 KG

**ASIENTOS**

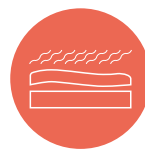

ESPUMAS DE  
DENSIDAD 25 KG,  
RECUBIERTO DE GUATA

**RESPALDOS**



CINCHA  
DE 80 MM

DUERO

		ALTO	FONDO	ANCHO	BULTOS	PLAZAS
	SOFÁ 3 PLAZAS (3 ASIENTOS) 180	1,07	0,75	1,80	1	3
	SOFÁ 2 PLAZAS (2 ASIENTOS) 132	1,07	0,75	1,32	1	2
	SILLÓN (1 PLAZA) 85	1,32	1,00	0,75	1	1

 **Juan Díaz, S.L.**

**SOFÁ 2/3 PLAZAS**  
**SILLÓN**

# “CLASIC”

SOFÁ 2/3 PLAZAS

SILLÓN



*Juan Díaz*

# “CLASICO”

SOFÁ 3 PLAZAS

SILLÓN



OPCIÓN SILLÓN

Juan Díaz

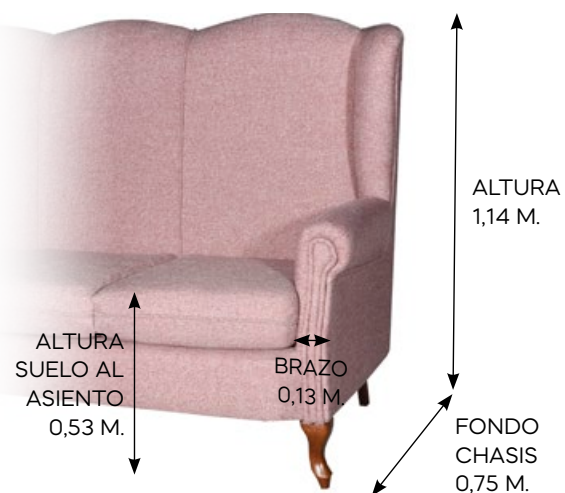

**ESTRUCTURA**

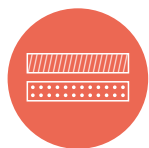

MADERA DE PINO MACIZO,  
CUBIERTO DE ESPUMA  
DENSIDAD 20 KG

**ASIENTOS**

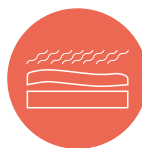



ESPUMAS DE  
DENSIDAD 25 KG,  
RECUBIERTO DE GUATA

**RESPALDOS**

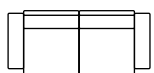

CINCHA  
DE 80 MM

CLASIC

		ALTO	FONDO	ANCHO	BULTOS	PLAZAS
	SOFÁ 3 PLAZAS (3 ASIENTOS) 190	1,14	0,75	1,90	1	3
	SOFÁ 2 PLAZAS (2 ASIENTOS) 130	1,14	0,75	1,30	1	2
	SILLÓN (1 PLAZA) 85	1,14	0,75	0,85	1	1

 **Juan Díaz, S.L.**

SOFÁ 2/3 PLAZAS  
SILLÓN

# “TORMES”

SOFÁ 3 PLAZAS

SILLÓN



*Juan Díaz*

# “TORMES”

SOFÁ 3 PLAZAS

SILLÓN



OPCIÓN SILLÓN

Juan Díaz

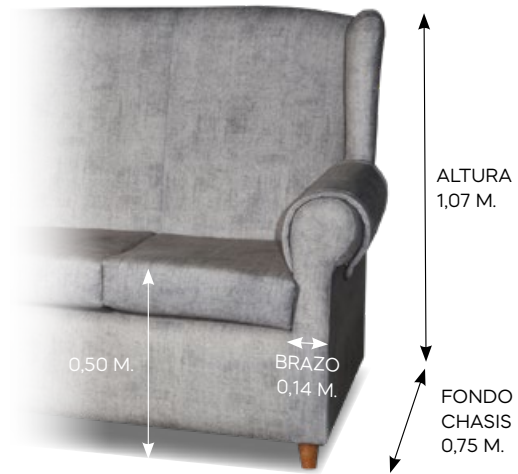

**ESTRUCTURA**

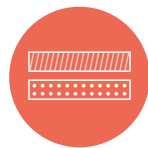

MADERA DE PINO MACIZO,  
CUBIERTO DE ESPUMA  
DENSIDAD 20 KG.

**ASIENTOS**



ESPUMAS DE  
DENSIDAD 25 KG.,  
RECUBIERTO DE GUATA

**RESPALDOS**



CINCHA DE 80 MM.

TORMES

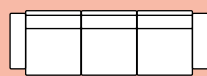

SOFÁ 3 PLAZAS (3 ASIENTOS) EXT. 180

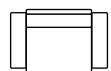

SILLÓN (1 PLAZA) EXT. 75 - RELAX

ALTO	FONDO	ANCHO	BULTOS	PLAZAS
1,07	0,75	1,80	1	3

1,07	0,75	0,75	1	1
------	------	------	---	---

 Tapizados Juan Díaz, S.L.

SOFÁ 3 PLAZAS  
SILLÓN



*Juan Díaz*

“RELAX 4”

“RELAX 6”

SILLÓN RELAX

SILLÓN RELAX



# “RELAX 4”

SILLÓN RELAX



# “RELAX 6”

SILLÓN RELAX



Juan Díaz

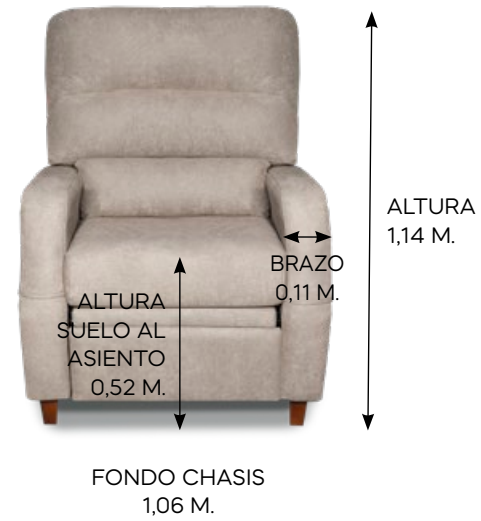
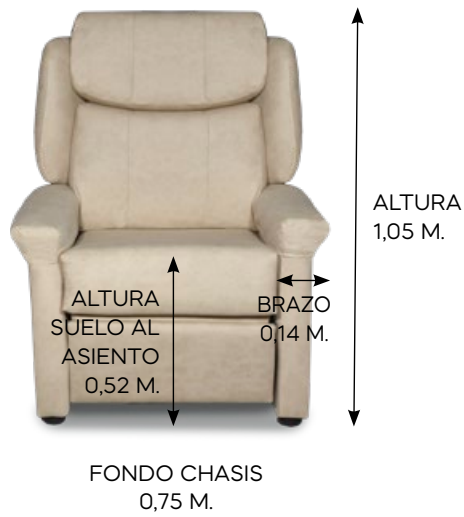

## RELAX 4

## RELAX 6

### ESTRUCTURA

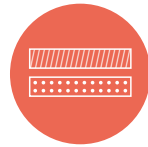

MADERA DE PINO MACIZO,  
CUBIERTO DE ESPUMA  
DENSIDAD 20 KG

### ASIENTOS

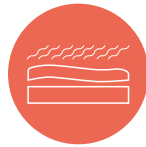

ESPUMAS DE  
DENSIDAD 25 KG,  
RECUBIERTO DE GUATA

### RESPALDOS



RELLENO DE ESPUMA Y  
FIBRA 100% SILICONADA.  
DESENFUNDABLE

### DE SERIE



SISTEMA RELAX MANUAL  
(APERTURA CON EL  
PESO DEL CUERPO)

## RELAX 4

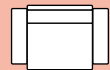

SILLÓN RELAX (1 PLAZA)

ALTO	FONDO	ANCHO	BULTOS	PLAZAS
1,05	0,75	0,70	1	1

## RELAX 6



SILLÓN RELAX (1 PLAZA)

ALTO	FONDO	ANCHO	BULTOS	PLAZAS
1,06	1,06	0,75	1	1

Tapizadores  
Juan Díaz, s.l.

SILLÓN RELAX

*Juan Díaz*

# “RELAX 3”

SILLÓN RELAX



# “RELAX 5”

SILLÓN RELAX



# “GERONA”

SILLÓN RELAX



# “RELAX 3”

SILLÓN RELAX



# “RELAX 5”

SILLÓN RELAX



MODELO GERONA ABIERTO

Juan Díaz

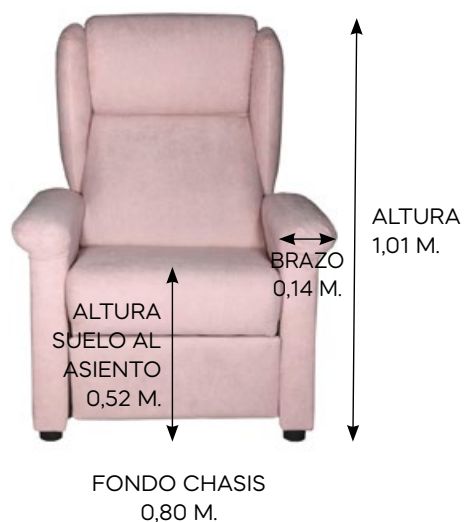

RELAX 3

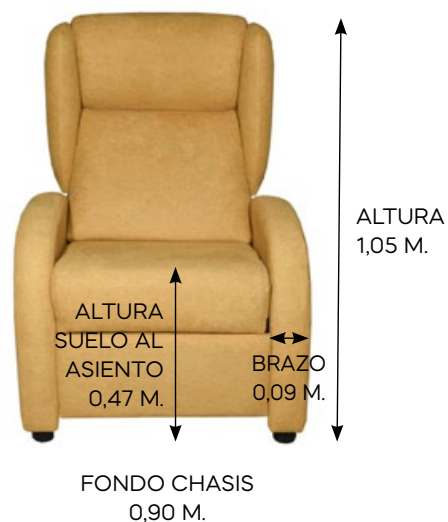

RELAX 5

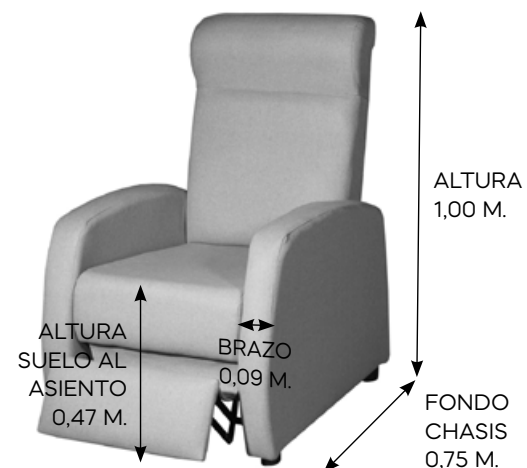

GERONA

ESTRUCTURA

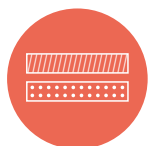

MADERA DE PINO MACIZO,  
CUBIERTO DE ESPUMA  
DENSIDAD 20 KG

ASIENTOS

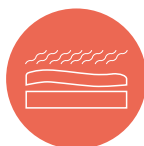

ESPUMAS DE  
DENSIDAD 25 KG,  
RECUBIERTO DE GUATA

RESPALDOS



ESPUMA  
20 KG

DE SERIE



SISTEMA RELAX MANUAL  
(APERTURA CON EL  
PESO DEL CUERPO)

RELAX 3

	ALTO	FONDO	ANCHO	BULTOS	PLAZAS
 SILLÓN RELAX (1 PLAZA)	1,01	0,80	0,80	1	1

RELAX 5

	ALTO	FONDO	ANCHO	BULTOS	PLAZAS
 SILLÓN RELAX (1 PLAZA)	1,05	0,90	0,70	1	1

GERONA

	ALTO	FONDO	ANCHO	BULTOS	PLAZAS
 SILLÓN RELAX (1 PLAZA)	1,00	0,75	0,70	1	1

 *Tapizados* Juan Díaz, S.L.

SILLÓN RELAX

*Juan Díaz*

“RON”

SILLÓN



“CUBO”

SILLÓN



“RON”

SILLÓN

“CUBO”

SILLÓN

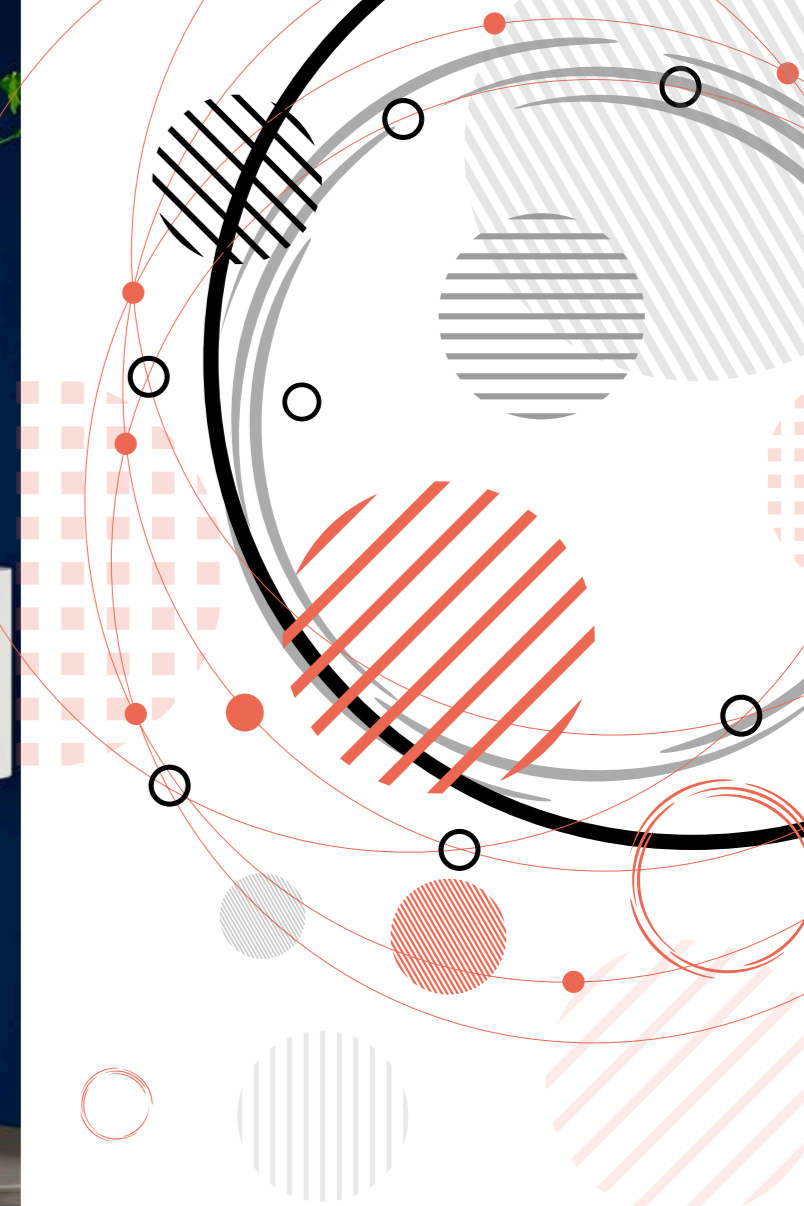



Juan Díaz

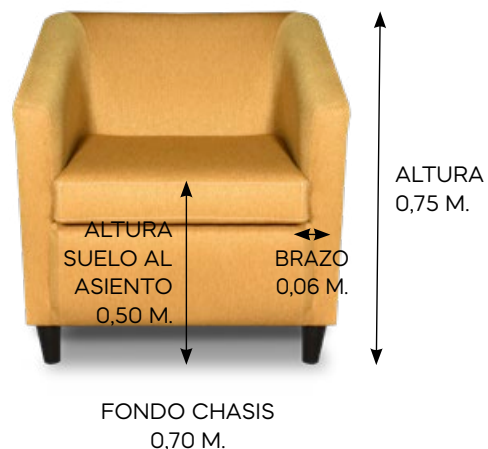

RON

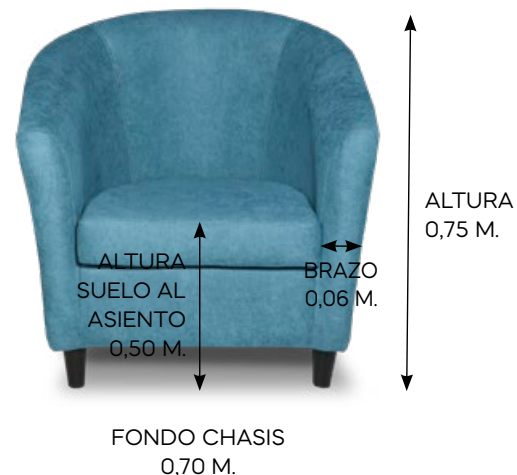

CUBO

**ESTRUCTURA**

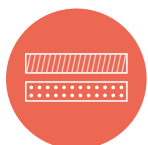

MADERA DE PINO MACIZO,  
CUBIERTO DE ESPUMA  
DENSIDAD 20 KG

**ASIENTOS**



ESPUMAS DE  
DENSIDAD 25 KG,  
RECUBIERTO DE GUATA.  
CINCHA DE 80 MM

**RESPALDOS**



CINCHA  
DE 40 MM

RON / CUBO

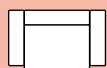

SILLÓN (1 PLAZA)

ALTO	FONDO	ANCHO	BULTOS	PLAZAS
0,75	0,70	0,73	1	1

 Tapizados Juan Díaz, S.L.

SILLÓN

# “SIRA”

BUTACA



*Juan Díaz*



# “SIRA”

BUTACA



Juan Díaz

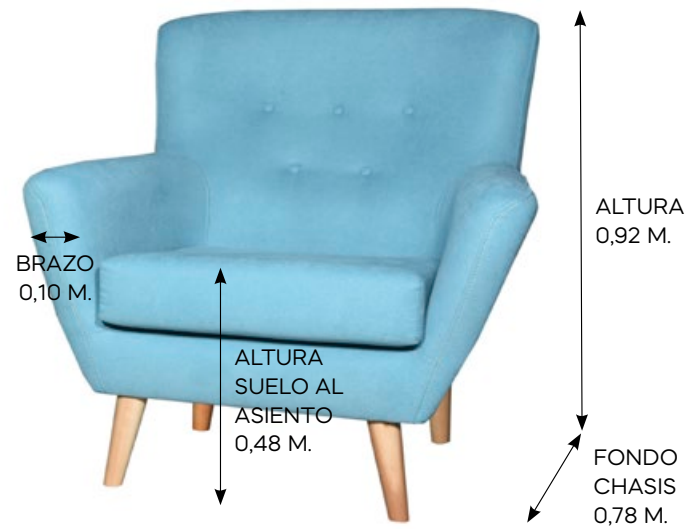

### ESTRUCTURA

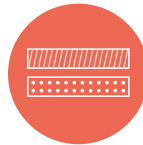

MADERA PINO MACIZO,  
CUBIERTO DE ESPUMA  
DENSIDAD 20KG

### ASIENTOS

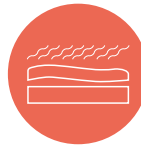

ESPUMAS DE DENSIDAD  
25 KG, RECUBIERTO  
DE GUATA

### RESPALDOS



CINCHA  
DE 80 MM

# SIRA



SILLÓN BUTACA

ALTO	FONDO	ANCHO	BULTOS	PLAZAS
0,92	0,78	0,79	1	1

 Tapizados  
Juan Díaz, S.L.

BUTACA

*Juan Díaz*

“GOS”

BUTACA



“NUT”

BUTACA



“GOS”

BUTACA



“NUT”

BUTACA



Juan Díaz

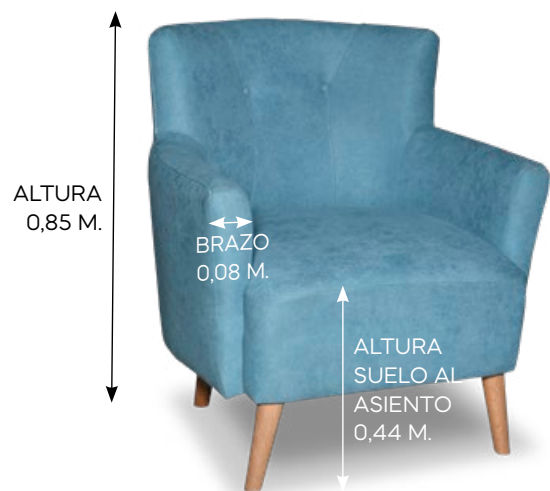

**ESTRUCTURA**

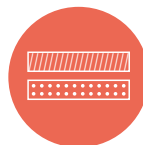

MADERA DE PINO CON  
LATERALES DE AGLOMERADO  
ALTA RESISTENCIA

**ASIENTOS**



ESPUMAS DE  
DENSIDAD 25 KG

**RESPALDOS**



ESPUMAS DE  
DENSIDAD 20 KG

GOS

	ALTO	FONDO	ANCHO	BULTOS	PLAZAS
 BUTACA	0,85	0,68	0,71	1	1

 Tapizados  
Juan Díaz, S.L.

BUTACA

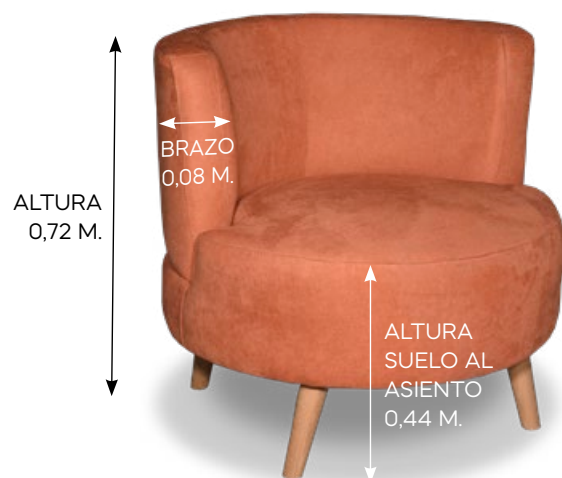

**ESTRUCTURA**

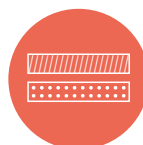

MADERA DE PINO CON  
LATERALES DE AGLOMERADO  
ALTA RESISTENCIA

**ASIENTOS**



ESPUMAS DE  
DENSIDAD 25 KG

**RESPALDOS**



ESPUMAS DE  
DENSIDAD 20 KG

NUT

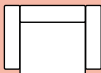
	ALTO	FONDO	ANCHO	BULTOS	PLAZAS
 BUTACA	0,72	0,68	0,69	1	1

 Tapizados  
Juan Díaz, S.L.

BUTACA

*Juan Díaz*

“OREJA 10”

SILLÓN OREJERO



“PUFF”

PUFF FIJO

PUFF CANAPÉ





# “OREJA 10”

SILLÓN



# “PUFF”

PUFF FIJO

PUFF CANAPÉ



Juan Díaz

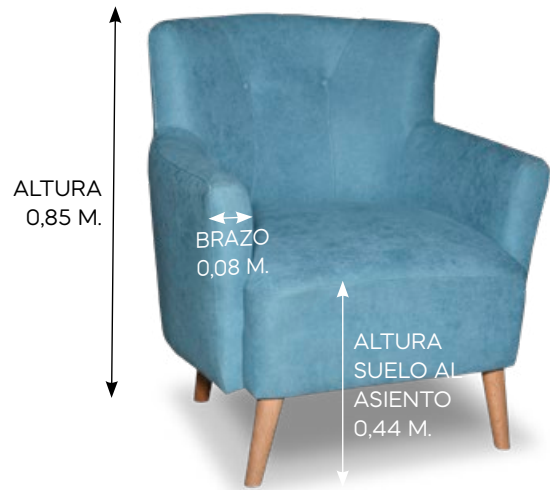

**ESTRUCTURA**

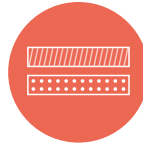

MADERA DE PINO CON  
LATERALES DE AGLOMERADO  
ALTA RESISTENCIA

**ASIENTOS**

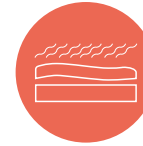

ESPUMAS DE  
DENSIDAD 25 KG

**RESPALDOS**



ESPUMAS DE  
DENSIDAD 20 KG

GOS

	ALTO	FONDO	ANCHO	BULTOS	PLAZAS
 BUTACA	0,85	0,68	0,71	1	1

 Tapizados Juan Díaz, S.L.

BUTACA

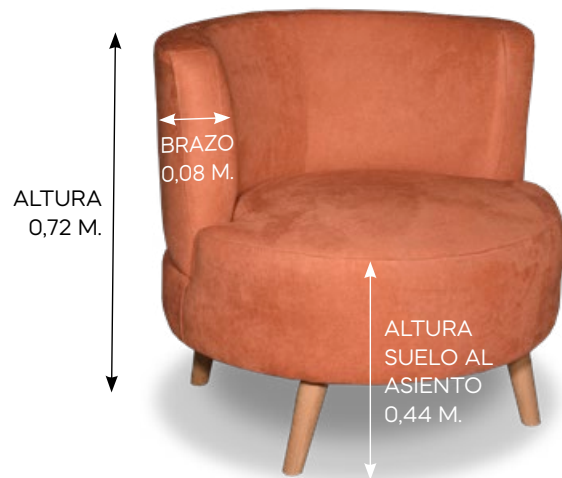

**ESTRUCTURA**

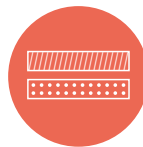

MADERA DE PINO CON  
LATERALES DE AGLOMERADO  
ALTA RESISTENCIA

**ASIENTOS**

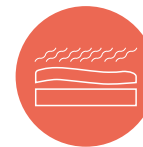

ESPUMAS DE  
DENSIDAD 25 KG

**RESPALDOS**



ESPUMAS DE  
DENSIDAD 20 KG

NUT

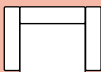
	ALTO	FONDO	ANCHO	BULTOS	PLAZAS
 BUTACA	0,72	0,68	0,69	1	1

 Tapizados Juan Díaz, S.L.

BUTACA

Juan Díaz



CTRA. CIRCUNVALACIÓN, S/N  
06460 **CAMPANARIO** (BADAJOZ)

TLF: 924 831 277

E-MAIL: [juandiaz@tapizadosjuandiaz.com](mailto:juandiaz@tapizadosjuandiaz.com)

[WWW.TAPIZADOSJUANDIAZ.COM](http://WWW.TAPIZADOSJUANDIAZ.COM)